



Welding machine

Tetrix 351 Smart FW
Tetrix 401 Smart FW
Tetrix 451 Smart FW
Tetrix 551 Smart FW

099-000128-EW501

16.07.2014

Register now!
For your benefit
Jetzt Registrieren
und Profitieren!

www.ewm-group.com



General instructions

CAUTION



Read the operating instructions!

The operating instructions provide an introduction to the safe use of the products.

- Read the operating instructions for all system components!
- Observe accident prevention regulations!
- Observe all local regulations!
- Confirm with a signature where appropriate.

NOTE



In the event of queries on installation, commissioning, operation or special conditions at the installation site, or on usage, please contact your sales partner or our customer service department on +49 2680 181-0.

A list of authorised sales partners can be found at www.ewm-group.com.

Liability relating to the operation of this equipment is restricted solely to the function of the equipment. No other form of liability, regardless of type, shall be accepted. This exclusion of liability shall be deemed accepted by the user on commissioning the equipment.

The manufacturer is unable to monitor whether or not these instructions or the conditions and methods are observed during installation, operation, usage and maintenance of the equipment.

An incorrectly performed installation can result in material damage and injure persons as a result. For this reason, we do not accept any responsibility or liability for losses, damages or costs arising from incorrect installation, improper operation or incorrect usage and maintenance or any actions connected to this in any way.

1 Contents

1	Contents	3
2	Safety instructions	7
2.1	Notes on the use of these operating instructions	7
2.2	Explanation of icons	8
2.3	General	9
2.4	Transport and installation	13
2.4.1	Lifting by crane	14
2.4.2	Ambient conditions	15
2.4.2.1	In operation	15
2.4.2.2	Transport and storage	15
3	Intended use	16
3.1	Applications	16
3.1.1	TIG welding	16
3.1.1.1	activArc	16
3.1.1.2	spotArc	16
3.1.1.3	Spotmatic	16
3.1.2	MMA welding	16
3.2	Documents which also apply	17
3.2.1	Warranty	17
3.2.2	Declaration of Conformity	17
3.2.3	Welding in environments with increased electrical hazards	17
3.2.4	Service documents (spare parts and circuit diagrams)	17
3.2.5	Calibration/Validation	17
4	Machine description – quick overview	18
4.1	Front view	18
4.2	Rear view	20
4.3	Machine control – Operating elements	22
4.3.1	Function sequence	23
5	Design and function	24
5.1	General	24
5.2	Installation	25
5.3	Machine cooling	25
5.4	Workpiece lead, general	25
5.5	Welding torch cooling system	26
5.5.1	List of coolants	26
5.5.2	Adding coolant	27
5.6	Mains connection	28
5.6.1	Mains configuration	28
5.7	Notes on the installation of welding current leads	29
5.8	TIG welding	31
5.8.1	Welding torch and workpiece line connection	31
5.8.1.1	Torch connection options and pin assignments	32
5.8.2	Shielding gas supply (shielding gas cylinder for welding machine)	33
5.8.2.1	Connecting the shielding gas supply	34
5.8.2.2	Setting the shielding gas quantity	34
5.8.3	Select welding task	35
5.8.3.1	Welding data display	35
5.8.3.2	Expert menu (TIG)	36
5.8.4	Arc ignition	37
5.8.4.1	HF ignition	37
5.8.4.2	Liftarc ignition	37
5.8.4.3	Automatic cut-out	37
5.8.5	Function sequences/operating modes	38
5.8.5.1	Explanation of symbols	38
5.8.5.2	Non-latched mode	39
5.8.5.3	Latched mode	40

5.8.5.4	TIG spotArc	41
5.8.5.5	Spotmatic	43
5.8.5.6	Non-latched operation, version C.....	45
5.8.5.7	Automated pulses.....	46
5.8.5.8	TIG pulses – non-latched operation	46
5.8.5.9	TIG pulses - latched operation	46
5.8.6	TIG <i>activArc</i> welding.....	47
5.8.7	Welding torch (operating variants).....	48
5.8.7.1	Tap torch trigger (tapping function)	48
5.8.7.2	Torch mode and up/down speed setting	49
5.8.7.3	Standard TIG torch (5-pole)	50
5.8.7.4	TIG up/down torch (8-pole)	52
5.8.7.5	Potentiometer torch (8-pole)	54
5.8.7.6	Configuring the TIG potentiometer torch connection	55
5.8.7.7	Setting the first increment.....	56
5.9	MMA welding.....	57
5.9.1	Connecting the electrode holder and workpiece lead	57
5.9.2	Select welding task	59
5.9.2.1	Hotstart current and Hotstart time	59
5.9.2.2	Arcforce	60
5.9.2.3	Antistick	60
5.10	Remote control.....	61
5.10.1	Manual remote control RT1 19POL.....	61
5.10.2	RTG1 19POL manual remote control	61
5.10.3	Manual remote control RTP1 19POL	61
5.10.4	Manual remote control RTP2 19POL	61
5.10.5	RTP3 spotArc 19POL manual remote control	61
5.10.6	Foot-operated remote control RTF1 19POL.....	62
5.10.6.1	Ramp function foot-operated remote control RTF 1	63
5.10.7	Foot-operated remote control RTF2 19POL 5m.....	63
5.11	Interfaces for automation	63
5.11.1	Remote control connection socket, 19-pole	64
5.11.2	TIG interface for mechanised welding	65
5.12	PC Interfaces	66
5.13	Machine configuration menu	66
5.13.1	Selecting, changing and saving parameters.....	66
6	Maintenance, care and disposal	70
6.1	General.....	70
6.2	Maintenance work, intervals	70
6.2.1	Daily maintenance tasks.....	70
6.2.1.1	Visual inspection	70
6.2.1.2	Functional test.....	70
6.2.2	Monthly maintenance tasks	70
6.2.2.1	Visual inspection	70
6.2.2.2	Functional test.....	70
6.2.3	Annual test (inspection and testing during operation)	71
6.3	Disposing of equipment.....	71
6.3.1	Manufacturer's declaration to the end user	71
6.4	Meeting the requirements of RoHS.....	71
6.5	Checklist for rectifying faults	72
6.6	Error messages (power source).....	74
6.7	Resetting welding parameters to the factory settings	76
6.8	Display machine control software version.....	77
6.9	General operating problems	77
6.9.1	Interface for automated welding	77
6.10	Vent coolant circuit.....	78
7	Technical data.....	79
7.1	Tetrix 351 FW.....	79
7.2	Tetrix 401 FW.....	80
7.3	Tetrix 451 FW.....	81

7.4	Tetrix 551 FW	82
8	Accessories	83
8.1	Remote controls and accessories.....	83
8.2	Options.....	83
8.3	General accessories	84
8.4	Computer communication.....	84
9	Appendix A	85
9.1	Overview of EWM branches	85

2 Safety instructions

2.1 Notes on the use of these operating instructions

DANGER

Working or operating procedures which must be closely observed to prevent imminent serious and even fatal injuries.

- Safety notes include the "DANGER" keyword in the heading with a general warning symbol.
- The hazard is also highlighted using a symbol on the edge of the page.

WARNING

Working or operating procedures which must be closely observed to prevent serious and even fatal injuries.

- Safety notes include the "WARNING" keyword in the heading with a general warning symbol.
- The hazard is also highlighted using a symbol in the page margin.

CAUTION

Working or operating procedures which must be closely observed to prevent possible minor personal injury.

- The safety information includes the "CAUTION" keyword in its heading with a general warning symbol.
- The risk is explained using a symbol on the edge of the page.

CAUTION

Working and operating procedures which must be followed precisely to avoid damaging or destroying the product.

- The safety information includes the "CAUTION" keyword in its heading without a general warning symbol.
- The hazard is explained using a symbol at the edge of the page.

NOTE













Special technical points which users must observe.

- Notes include the "NOTE" keyword in the heading without a general warning symbol.

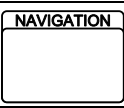
Instructions and lists detailing step-by-step actions for given situations can be recognised via bullet points, e.g.:

- Insert the welding current lead socket into the relevant socket and lock.

2.2 Explanation of icons

Symbol	Description
	Press
	Do not press
	Turn
	Switch
	Switch off machine
	Switch on machine
	ENTER (enter the menu)
	NAVIGATION (Navigating in the menu)
	EXIT (Exit the menu)
	Time display (example: wait 4s/press)
	Interruption in the menu display (other setting options possible)
	Tool not required/do not use
	Tool required/use

2.3 General

DANGER



Electric shock!

Welding machines use high voltages which can result in potentially fatal electric shocks and burns on contact. Even low voltages can cause you to get a shock and lead to accidents.

- Do not touch any live parts in or on the machine!
- Connection cables and leads must be free of faults!
- Switching off alone is not sufficient!
- Place welding torch and stick electrode holder on an insulated surface!
- The unit should only be opened by specialist staff after the mains plug has been unplugged!
- Only wear dry protective clothing!
- Wait for 4 minutes until the capacitors have discharged!



Electromagnetic fields!

The power source may cause electrical or electromagnetic fields to be produced which could affect the correct functioning of electronic equipment such as IT or CNC devices, telecommunication lines, power cables, signal lines and pacemakers.

- Observe the maintenance instructions! (see Maintenance and Testing chapter)
- Unwind welding leads completely!
- Shield devices or equipment sensitive to radiation accordingly!
- The correct functioning of pacemakers may be affected (obtain advice from a doctor if necessary).



Do not carry out any unauthorised repairs or modifications!

To avoid injury and equipment damage, the unit must only be repaired or modified by specialist, skilled persons!

The warranty becomes null and void in the event of unauthorised interference.

- Appoint only skilled persons for repair work (trained service personnel)!

WARNING



Risk of accidents if these safety instructions are not observed!

Non-observance of these safety instructions is potentially fatal!

- Carefully read the safety information in this manual!
- Observe the accident prevention regulations in your country.
- Inform persons in the working area that they must observe the regulations!



Risk of injury due to radiation or heat!

Arc radiation results in injury to skin and eyes.

Contact with hot workpieces and sparks results in burns.

- Use welding shield or welding helmet with the appropriate safety level (depending on the application)!
- Wear dry protective clothing (e.g. welding shield, gloves, etc.) according to the relevant regulations in the country in question!
- Protect persons not involved in the work against arc beams and the risk of glare using safety curtains!

WARNING



Explosion risk!

Apparently harmless substances in closed containers may generate excessive pressure when heated.

- Move containers with inflammable or explosive liquids away from the working area!
- Never heat explosive liquids, dusts or gases by welding or cutting!



Smoke and gases!

Smoke and gases can lead to breathing difficulties and poisoning. In addition, solvent vapour (chlorinated hydrocarbon) may be converted into poisonous phosgene due to the ultraviolet radiation of the arc!

- Ensure that there is sufficient fresh air!
- Keep solvent vapour away from the arc beam field!
- Wear suitable breathing apparatus if appropriate!



Fire hazard!

Flames may arise as a result of the high temperatures, stray sparks, glowing-hot parts and hot slag produced during the welding process.

Stray welding currents can also result in flames forming!

- Check for fire hazards in the working area!
- Do not carry any easily flammable objects such as matches or lighters.
- Keep appropriate fire extinguishing equipment to hand in the working area!
- Thoroughly remove any residue of flammable substances from the workpiece before starting welding.
- Only continue work on welded workpieces once they have cooled down.
Do not allow to come into contact with flammable material!
- Connect welding leads correctly!



Danger when coupling multiple power sources!

Coupling multiple power sources in parallel or in series has to be carried out by qualified personnel and in accordance with the manufacturer's guidelines. Before bringing the power sources into service for arc welding operations, a test has to verify that they cannot exceed the maximum allowed open circuit voltage.

- Connection of the machine may be carried out by qualified personnel only!
- When decommissioning individual power sources, all mains and welding current leads have to be safely disconnected from the welding system as a whole. (Danger due to inverse voltages!)
- Do not couple welding machines with pole reversing switch (PWS series) or machines for AC welding, as a minor error in operation can cause the welding voltages to be combined.

CAUTION



Noise exposure!

Noise exceeding 70 dBA can cause permanent hearing damage!

- Wear suitable ear protection!
- Persons located within the working area must wear suitable ear protection!

CAUTION**Obligations of the operator!**

The respective national directives and laws must be observed for operation of the machine!

- National implementation of the framework directive (89/391/EWG), as well as the associated individual directives.
- In particular, directive (89/655/EWG), on the minimum regulations for safety and health protection when staff members use equipment during work.
- The regulations regarding work safety and accident prevention for the respective country.
- Setting up and operating the machine according to IEC 60974-9.
- Check at regular intervals that users are working in a safety-conscious way.
- Regular checks of the machine according to IEC 60974-4.

**Damage due to the use of non-genuine parts!**

The manufacturer's warranty becomes void if non-genuine parts are used!

- Only use system components and options (power sources, welding torches, electrode holders, remote controls, spare parts and replacement parts, etc.) from our range of products!
- Only insert and lock accessory components into the relevant connection socket when the machine is switched off.

**Damage to the machine due to stray welding currents!**

Stray welding currents can destroy protective earth conductors, damage equipment and electronic devices and cause overheating of components leading to fire.

- Make sure all welding leads are securely connected and check regularly.
- Always ensure a proper and secure electrical connection to the workpiece!
- Set up, attach or suspend all conductive power source components like casing, transport vehicle and crane frames so they are insulated!
- Do not place any other electronic devices such as drillers or angle grinders, etc., on the power source, transport vehicle or crane frames unless they are insulated!
- Always put welding torches and electrode holders on an insulated surface when they are not in use!

**Mains connection****Requirements for connection to the public mains network**

High-performance machines can influence the mains quality by taking current from the mains network. For some types of machines, connection restrictions or requirements relating to the maximum possible line impedance or the necessary minimum supply capacity at the interface with the public network (Point of Common Coupling, PCC) can therefore apply. In this respect, attention is also drawn to the machines' technical data. In this case, it is the responsibility of the operator, where necessary in consultation with the mains network operator, to ensure that the machine can be connected.

CAUTION



EMC Machine Classification

In accordance with IEC 60974-10, welding machines are grouped in two electromagnetic compatibility classes (see technical data):

Class A machines are not intended for use in residential areas where the power supply comes from the low-voltage public mains network. When ensuring the electromagnetic compatibility of class A machines, difficulties can arise in these areas due to interference not only in the supply lines but also in the form of radiated interference.

Class B machines fulfil the EMC requirements in industrial as well as residential areas, including residential areas connected to the low-voltage public mains network.

Setting up and operating

When operating arc welding systems, in some cases, electro-magnetic interference can occur although all of the welding machines comply with the emission limits specified in the standard. The user is responsible for any interference caused by welding.

In order to **evaluate** any possible problems with electromagnetic compatibility in the surrounding area, the user must consider the following: (see also EN 60974-10 Appendix A)

- Mains, control, signal and telecommunication lines
- Radios and televisions
- Computers and other control systems
- Safety equipment
- The health of neighbouring persons, especially if they have a pacemaker or wear a hearing aid
- Calibration and measuring equipment
- The immunity to interference of other equipment in the surrounding area
- The time of day at which the welding work must be carried out

Recommendations for **reducing interference emission**

- Mains connection, e.g. additional mains filter or shielding with a metal tube
- Maintenance of the arc welding equipment
- Welding leads should be as short as possible and run closely together along the ground
- Potential equalization
- Earthing of the workpiece. In cases where it is not possible to earth the workpiece directly, it should be connected by means of suitable capacitors.
- Shielding from other equipment in the surrounding area or the entire welding system

2.4 Transport and installation

WARNING



Incorrect handling of shielding gas cylinders!

Incorrect handling of shielding gas cylinders can result in serious and even fatal injury.

- Observe the instructions from the gas manufacturer and in any relevant regulations concerning the use of compressed air!
- Place shielding gas cylinders in the holders provided for them and secure with fixing devices.
- Avoid heating the shielding gas cylinder!

CAUTION



Risk of tipping!

There is a risk of the machine tipping over and injuring persons or being damaged itself during movement and set up. Tilt resistance is guaranteed up to an angle of 10° (according to EN 60974-A2).

- Set up and transport the machine on level, solid ground!
- Secure add-on parts using suitable equipment!
- Replace damaged wheels and their fixing elements!
- Fix external wire feed units during transport (avoid uncontrolled rotation)!



Damage due to supply lines not being disconnected!

During transport, supply lines which have not been disconnected (mains supply leads, control leads, etc.) may cause hazards such as connected equipment tipping over and injuring persons!

- Disconnect supply lines!

CAUTION



Equipment damage when not operated in an upright position!

The units are designed for operation in an upright position!

Operation in non-permissible positions can cause equipment damage.

- Only transport and operate in an upright position!

2.4.1 Lifting by crane

WARNING



Risk of injury during lifting by crane!

When lifting the machine by crane, persons may be severely injured by falling machines or mount-on components.

- Simultaneous lifting of system components such as power source, wire feeder or cooling unit is not allowed. Each system component has to be lifted separately!
- Remove any supply leads and accessories before lifting by crane (e.g. hose package, wire spool, shielding gas cylinder, toolbox, wire feeder, remote control, etc.)!
- Properly close and lock all casing covers and protective caps before lifting by crane!
- Use the correct number of hoisting equipment of the right size and right capacity! Observe craning principle (see figure)!
- For machines with lifting eyes: always lift all lifting eyes simultaneously!
- When using retrofitted craning frames etc.: always use at least two lifting points positioned as far apart as possible – observe option description.
- Avoid any jerky movements!
- Ensure that the load is distributed evenly! • Use chain hoists and chain slings of the same length only!
- Stay outside the danger zone underneath the machine!
- Observe the regulations regarding occupational safety and accident prevention for the respective country.

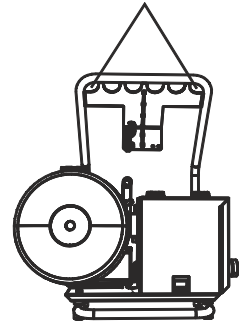
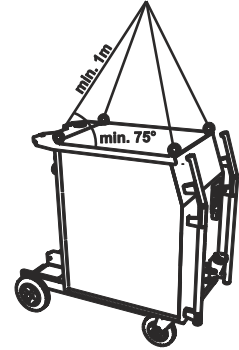

Craning principle



Risk of injury due to unsuitable lifting eye!

In case of improper use of lifting eyes or the use of unsuitable lifting eyes, persons can be seriously damaged by falling equipment or add-on components!

- The lifting eye must be completely screwed in!
- The lifting eye must be positioned flat onto and in full contact with the supporting surfaces!
- Check that the lifting eyes are securely fastened before use and check for any damage (corrosion, deformation)!
- Do not use or screw in damaged lifting eyes!
- Avoid lateral loading of the lifting eyes!

2.4.2 Ambient conditions

CAUTION



Installation site!

The machine must not be operated in the open air and must only be set up and operated on a suitable, stable and level base!

- The operator must ensure that the ground is non-slip and level, and provide sufficient lighting for the place of work.
- Safe operation of the machine must be guaranteed at all times.

CAUTION



Equipment damage due to dirt accumulation!

Unusually high quantities of dust, acid, corrosive gases or substances may damage the equipment.

- Avoid high volumes of smoke, vapour, oil vapour and grinding dust!
- Avoid ambient air containing salt (sea air)!



Non-permissible ambient conditions!

Insufficient ventilation results in a reduction in performance and equipment damage.

- Observe the ambient conditions!
- Keep the cooling air inlet and outlet clear!
- Observe the minimum distance of 0.5 m from obstacles!

2.4.2.1 In operation

Temperature range of the ambient air:

- -25 °C to +40 °C

Relative air humidity:

- Up to 50% at 40 °C
- Up to 90% at 20 °C

2.4.2.2 Transport and storage

Storage in an enclosed space, temperature range of the ambient air:

- -30 °C to +70 °C

Relative air humidity

- Up to 90% at 20 °C

3 Intended use

WARNING



Hazards due to improper usage!

Hazards may arise for persons, animals and material objects if the equipment is not used correctly. No liability is accepted for any damages arising from improper usage!

- The equipment must only be used in line with proper usage and by trained or expert staff!
- Do not modify or convert the equipment improperly!

3.1 Applications

3.1.1 TIG welding

TIG welding with direct current.

Non-contact HF ignition or contact ignition with Liftarc.

3.1.1.1 **activArc**

The EWM activArc process, thanks to the highly dynamic controller system, ensures that the power supplied is kept virtually constant in the event of changes in the distance between the welding torch and the weld pool, e.g. during manual welding. Voltage losses as a result of a shortening of the distance between the torch and molten pool are compensated by a current rise (ampere per volt - A/V), and vice versa. This helps prevent the tungsten electrode sticking in the molten pool and the tungsten inclusions are reduced. This is particularly useful in tacking and in spot welding.

3.1.1.2 **spotArc**

This process is suitable for tack welding or joint welding of metal sheets made from steel and CrNi alloys up to a thickness of approximately 2.5 mm. Metal sheets of different thicknesses can also be welded on top of one another. As this is a one-sided process, it is also possible to weld metal sheets onto tubular sections such as round or square pipes. In arc spot welding, the arc melts through the upper metal sheet and the lower metal sheet is melted onto it. This produces flat, fine-textured welding tacks which require little or no post weld work, even in visible areas.

3.1.1.3 **Spotmatic**

In contrast to the operating mode spotArc, the arc ignites not by pressing the torch trigger as is usual, but by shortly touching the tungsten electrode against the workpiece. The torch trigger is used for process activation.

3.1.2 MMA welding

Manual arc welding or, for short, MMA welding. It is characterised by the fact that the arc burns between a melting electrode and the molten pool. There is no external protection; any protection against the atmosphere comes from the electrode.

3.2 Documents which also apply

3.2.1 Warranty

NOTE



For further information, please see the accompanying supplementary sheets "Machine and Company Data, Maintenance and Testing, Warranty"!

3.2.2 Declaration of Conformity



The designated machine conforms to EC Directives and standards in terms of its design and construction:

- EC Low Voltage Directive (2006/95/EC),
- EC EMC Directive (2004/108/EC),

This declaration shall become null and void in the event of unauthorised modifications, improperly conducted repairs, non-observance of the deadlines for the repetition test and / or non-permitted conversion work not specifically authorised by the manufacturer.

The original copy of the declaration of conformity is enclosed with the unit.

3.2.3 Welding in environments with increased electrical hazards



In compliance with IEC / DIN EN 60974, VDE 0544 the machines can be used in environments with an increased electrical hazard.

3.2.4 Service documents (spare parts and circuit diagrams)



DANGER



Do not carry out any unauthorised repairs or modifications!

To avoid injury and equipment damage, the unit must only be repaired or modified by specialist, skilled persons!

The warranty becomes null and void in the event of unauthorised interference.

- Appoint only skilled persons for repair work (trained service personnel)!

Original copies of the circuit diagrams are enclosed with the unit.

Spare parts can be obtained from the relevant authorised dealer.

3.2.5 Calibration/Validation

We hereby confirm that this machine has been tested using calibrated measuring equipment, as stipulated in IEC/EN 60974, ISO/EN 17662, EN 50504, and complies with the admissible tolerances. Recommended calibration interval: 12 months

4 Machine description – quick overview

NOTE

 The maximum possible machine configuration is given in the text description. If necessary, the optional connection may need to be retrofitted (see "Accessories" chapter).

4.1 Front view

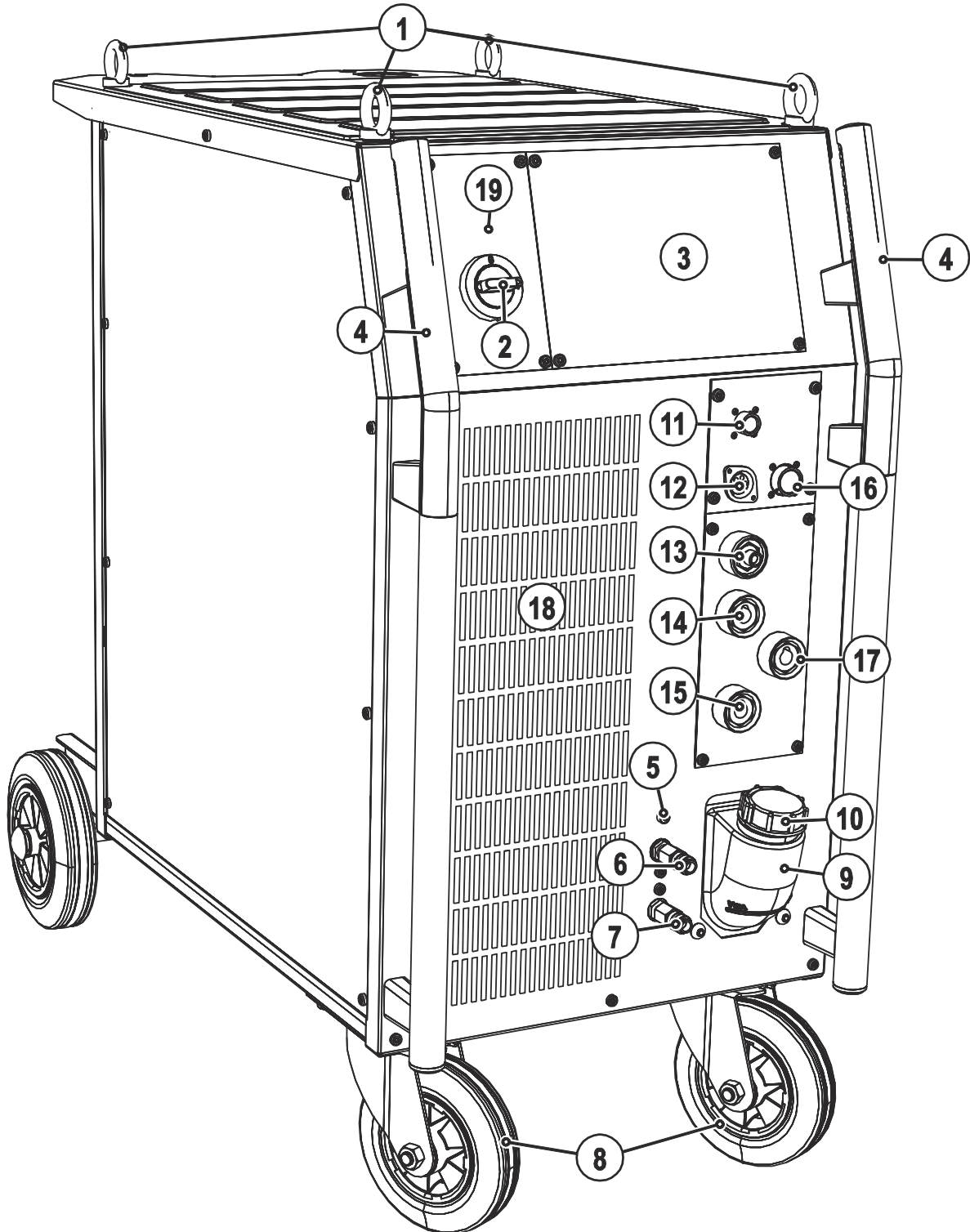













Figure 4-1

Item	Symbol	Description
1		Lifting lug
2		Main switch, machine on/off
3		Machine control See Machine control – operating elements chapter
4		Carrying handle
5		Automatic cut-out of coolant pump key button press to reset a triggered fuse
6		Quick connect coupling (red) coolant return
7		Quick connect coupling (blue) coolant supply
8		Wheels, guide castors
9		Coolant tank
10		Coolant tank cap
11		Connection socket, 8-pole TIG Up/Down or potentiometer torch control lead
12		Connection socket, 5-pole Standard TIG torch control lead
13		G1/4" connecting nipple, "-" welding current Shielding gas connection (with yellow insulating cap) for TIG welding torch
14		Connection socket, "-" welding current TIG welding torch connection
15		Connection socket, "+" welding current Connection for workpiece lead
16		Connection socket, 19-pole Remote control connection
17		Connection socket, "-" welding current Electrode holder connection
18		Cooling air inlet
19		Operating state signal lamp Lights up when the machine is ready for use.

4.2 Rear view

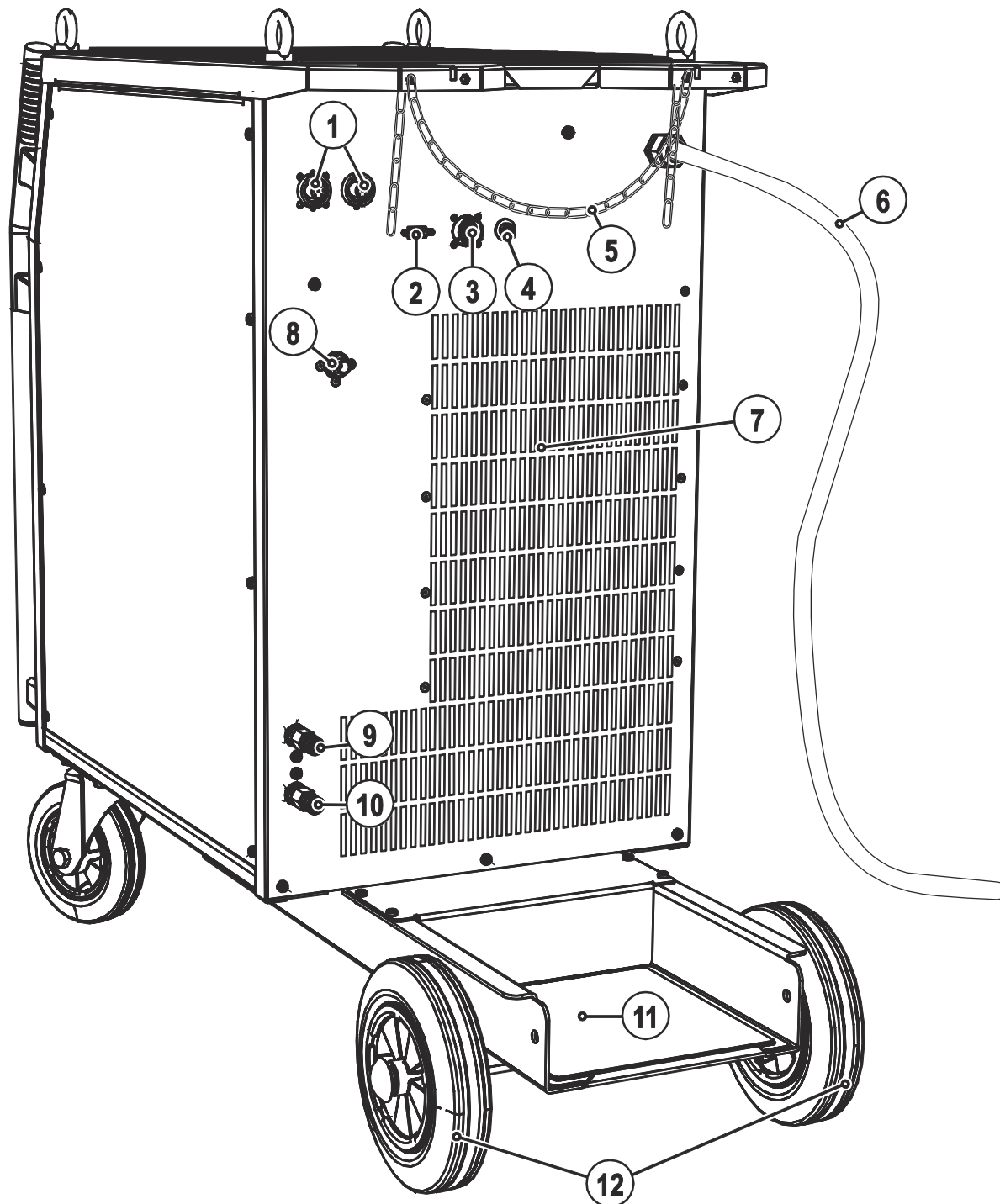









Figure 4-2

Item	Symbol	Description
1		7-pole connection socket (digital) For connecting digital accessory components
2		PC interface, serial (D-Sub connection socket, 9-pole)
3	 analog	19-pole mechanised welding interface (analogue) (See chapter entitled "Design and function > interfaces".)
4	 HF	Ignition type changeover switch ☒ = Liftarc (contact ignition) HF = HF ignition
5		Securing elements for shielding gas cylinder (strap/chain)
6		Mains connection cable
7		Cooling air outlet
8		G¹/₄" connecting nipple Shielding gas connection on the pressure regulator.
9		Quick connect coupling (red) coolant return
10		Quick connect coupling (blue) coolant supply
11		Bracket for shielding gas cylinder
12		Wheels, fixed castors

4.3 Machine control – Operating elements

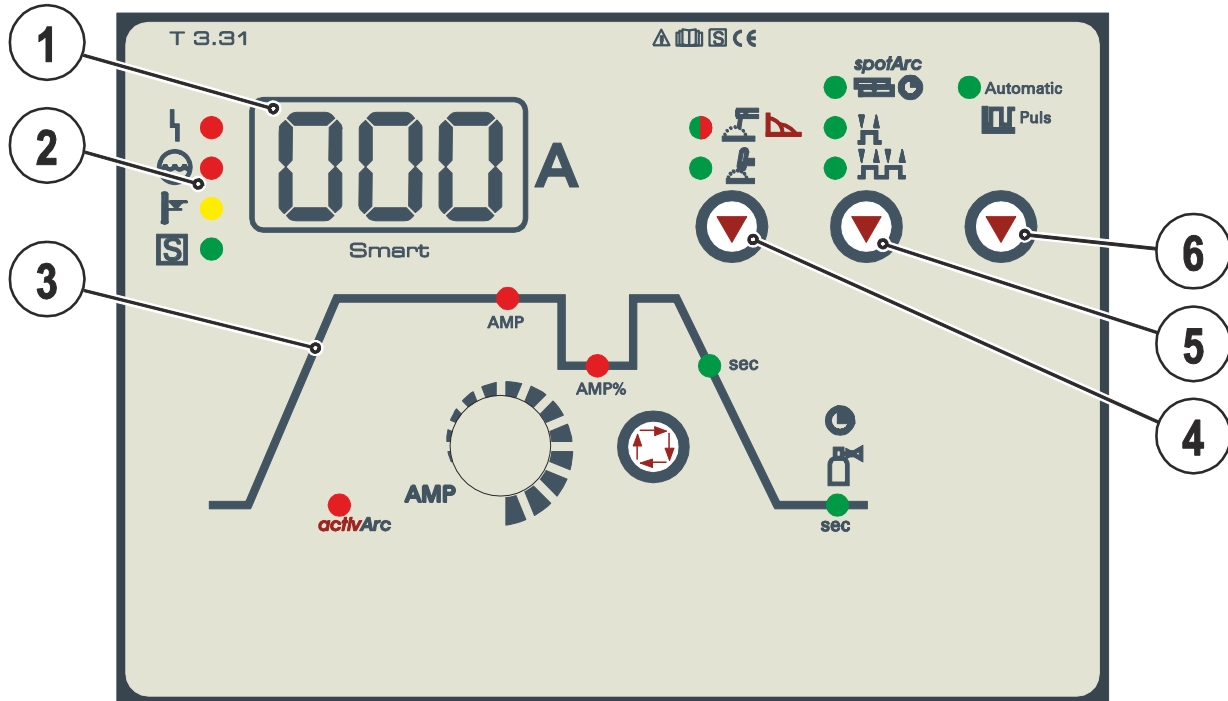

Figure 4-3

Item	Symbol	Description
1		Three-figure LED display Welding parameter display (see also chap. "Welding data display").
2		Error/status indicators Collective interference signal light Water deficiency signal light (welding torch cooling) Excess temperature signal light safety sign signal light
3		Function sequence (see next chapter)
4		Welding process button MMA welding, lights up in green / arcforce setting, lights up in red TIG welding
5		Operating mode button spotArc spotArc / Spotmatic (spot time setting range) Non-latched Latched
6		TIG pulse welding Automatic TIG automated pulses (frequency and balance)

4.3.1 Function sequence

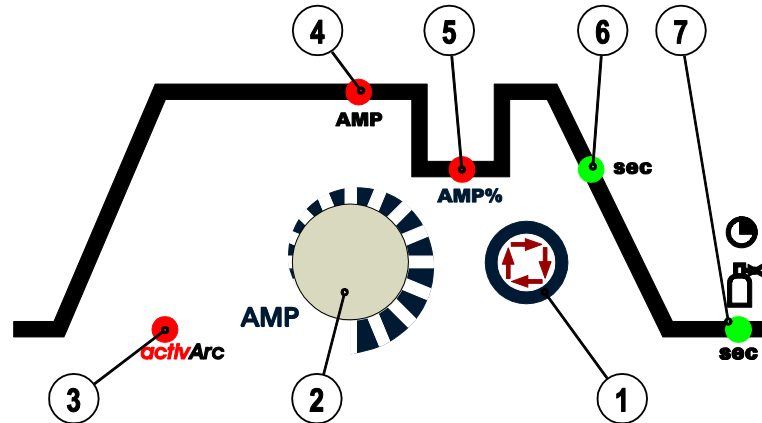

Figure 4-4

Item	Symbol	Description		
1		Select welding parameters button This button is used to select the welding parameters depending on the welding process and operating mode used.		
2		Welding parameter setting rotary dial Setting currents, times and parameters.		
3	activArc	activArc TIG welding process <ul style="list-style-type: none"> • Switch activArc on or off • Correct the activArc characteristic (setting range: 0 to 100) 		
4	AMP	<table border="1" style="width: 100%;"> <tr> <td style="width: 50%;">Main current (TIG) / pulse current I min to I max (1 A increments)</td> <td style="width: 50%;">Main current (MMA) I min to I max (1 A increments)</td> </tr> </table>	Main current (TIG) / pulse current I min to I max (1 A increments)	Main current (MMA) I min to I max (1 A increments)
Main current (TIG) / pulse current I min to I max (1 A increments)	Main current (MMA) I min to I max (1 A increments)			
5	AMP%	Secondary current (TIG) / pulse pause current Setting range 1 % to 100 % (1 % increments). Percentage of the main current.		
6	sec	Down-slope time (TIG) 0.00 s to 20.0 s (0.1 s increments). The down-slope time can be set separately for non-latched and latched.		
7	sec	Gas post-flow time (TIG) Setting ranges: 0.00 sec to 40.0 sec (0.1 sec increments).		

5 Design and function

5.1 General

WARNING



Risk of injury from electric shock!

Contact with live parts, e.g. welding current sockets, is potentially fatal!

- Follow safety instructions on the opening pages of the operating instructions.
- Commissioning may only be carried out by persons who have the relevant expertise of working with arc welding machines!
- Connection and welding leads (e.g. electrode holder, welding torch, workpiece lead, interfaces) may only be connected when the machine is switched off!

CAUTION



Insulate the arc welder from welding voltage!

Not all active parts of the welding current circuit can be shielded from direct contact. To avoid any associated risks it is vital for the welder to adhere to the relevant safety regulations. Even low voltages can cause a shock and lead to accidents.

- Wear dry and undamaged protective clothing (shoes with rubber soles/welder's gloves made from leather without any studs or braces)!
- Avoid direct contact with non-insulated connection sockets or connectors!
- Always place torches and electrode holders on an insulated surface!



Risk of burns on the welding current connection!

If the welding current connections are not locked, connections and leads heat up and can cause burns, if touched!

- Check the welding current connections every day and lock by turning in clockwise direction, if necessary.



Risk from electrical current!

If welding is carried out alternately using different methods and if a welding torch and an electrode holder remain connected to the machine, the open-circuit/welding voltage is applied simultaneously on all cables.

- The torch and the electrode holder should therefore always be placed on an insulated surface before starting work and during breaks.

CAUTION



Damage due to incorrect connection!

Accessory components and the power source itself can be damaged by incorrect connection!

- Only insert and lock accessory components into the relevant connection socket when the machine is switched off.
- Comprehensive descriptions can be found in the operating instructions for the relevant accessory components.
- Accessory components are detected automatically after the power source is switched on.



Using protective dust caps!

Protective dust caps protect the connection sockets and therefore the machine against dirt and damage.

- The protective dust cap must be fitted if there is no accessory component being operated on that connection.
- The cap must be replaced if faulty or if lost!

5.2 Installation

CAUTION



Installation site!

The machine must not be operated in the open air and must only be set up and operated on a suitable, stable and level base!

- The operator must ensure that the ground is non-slip and level, and provide sufficient lighting for the place of work.
- Safe operation of the machine must be guaranteed at all times.

5.3 Machine cooling

To obtain an optimal duty cycle from the power components, the following precautions should be observed:

- Ensure that the working area is adequately ventilated.
- Do not obstruct the air inlets and outlets of the machine.
- Do not allow metal parts, dust or other objects to get into the machine.

5.4 Workpiece lead, general

CAUTION



Risk of burns due to incorrect connection of the workpiece lead!

Paint, rust and dirt on the connection restrict the power flow and may lead to stray welding currents.

Stray welding currents may cause fires and injuries!

- Clean the connections!
- Fix the workpiece lead securely!
- Do not use structural parts of the workpiece as a return lead for the welding current!
- Take care to ensure faultless power connections!

5.5 Welding torch cooling system

CAUTION



Coolant mixtures!

Mixtures with other liquids or the use of unsuitable coolants result in material damage and renders the manufacturer's warranty void!

- Only use the coolant described in this manual (overview of coolants).
- Do not mix different coolants.
- When changing the coolant, the entire volume of liquid must be changed.



Insufficient frost protection in the welding torch coolant!

Depending on the ambient conditions, different liquids are used for cooling the welding torch (see overview of coolants).

Coolants with frost protection (KF 37E or KF 23E) must be checked regularly to ensure that the frost protection is adequate to prevent damage to the machine or the accessory components.

- The coolant must be checked for adequate frost protection with the TYP 1 frost protection tester (see accessories).
- Replace coolant as necessary if frost protection is inadequate!

NOTE



The disposal of coolant must be carried out according to official regulations and observing the relevant safety data sheets (German waste code number: 70104)!

- Coolant must not be disposed of together with household waste.
- Coolant must not be discharged into the sewerage system.
- Recommended cleaning agent: water, if necessary with cleaning agent added.

5.5.1 List of coolants

The following coolants may be used (for item nos., please see the Accessories chapter):

Coolant	Temperature range
KF 23E (Standard)	-10 °C to +40 °C
KF 37E	-20 °C to +10 °C

5.5.2 Adding coolant

The unit is supplied ex works with a minimum level of coolant.

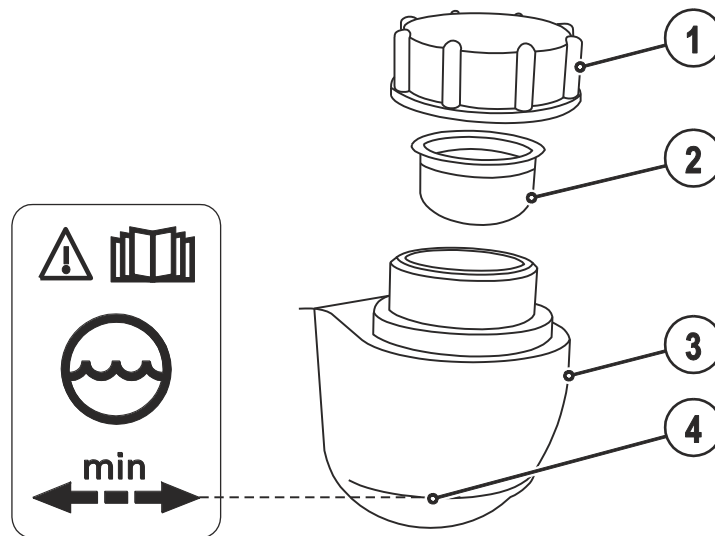

Figure 5-1

Item	Symbol	Description
1		Coolant tank cap
2		Coolant filter sieve
3		Coolant tank
4		"Min" mark Minimum coolant level

- Unscrew and remove the coolant tank sealing cover.
- Check filter sieve insert for dirt, clean if necessary and reinsert into position.
- Top up coolant to the filter sieve insert, close sealing cover again.

NOTE

- ☞ After the initial filling, wait for at least one minute when the machine is switched on so that the hose package is filled with coolant completely and without bubbles. With frequent changes of torch and during the initial filling process, the cooling unit tank should be topped up as necessary.
- ☞ The level of coolant must never fall below the "min" mark.
- ☞ If there is less coolant in the coolant tank than the minimum required you may need to vent the coolant circuit. In this case the welding machine will automatically shut down the coolant pump and signal an error, see chapter "Rectifying faults".

5.6 Mains connection

⚠ DANGER



Hazard caused by improper mains connection!

An improper mains connection can cause injuries or damage property!

- Only use machine with a plug socket that has a correctly fitted protective conductor.
- If a mains plug must be fitted, this may only be carried out by an electrician in accordance with the relevant national provisions or regulations!
- Mains plug, socket and lead must be checked regularly by an electrician!
- When operating the generator always ensure it is earthed as stated in the operating instructions. The resulting network has to be suitable for operating devices according to protection class 1.

5.6.1 Mains configuration

NOTE



The machine may be connected to:

- a three-phase system with four conductors and an earthed neutral conductor
- a three-phase system with three conductors of which any one can be earthed, e.g. the outer conductor

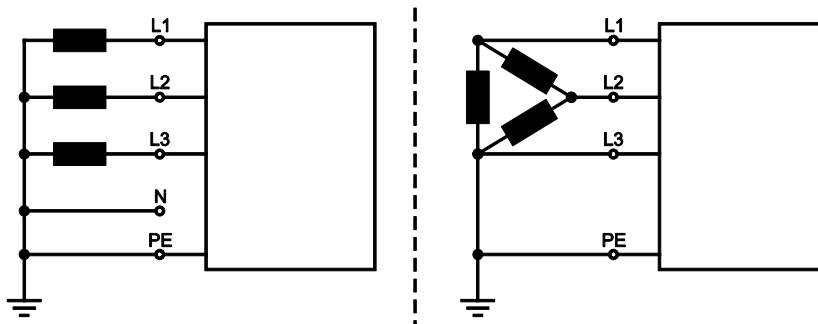

Figure 5-2

Legend

Item	Designation	Colour code
L1	Outer conductor 1	brown
L2	Outer conductor 2	black
L3	Outer conductor 3	grey
N	Neutral conductor	blue
PE	Protective conductor	green-yellow

CAUTION



Operating voltage - mains voltage!

The operating voltage shown on the rating plate must be consistent with the mains voltage, in order to avoid damage to the machine!

- For mains fuse protection, please refer to the "Technical data" chapter!

- Insert mains plug of the switched-off machine into the appropriate socket.

5.7 Notes on the installation of welding current leads

NOTE

-  Incorrectly installed welding current leads can cause faults in the arc (flickering).
Lay the workpiece lead and hose package of power sources without HF igniter (MIG/MAG) for as long and as close as possible in parallel.
- Lay the workpiece lead and hose package of power sources with HF igniter (TIG) for as long as possible in parallel with a distance of 20 cm to avoid HF sparkover.
- Always keep a distance of at least 20 cm to leads of other power sources to avoid interferences.

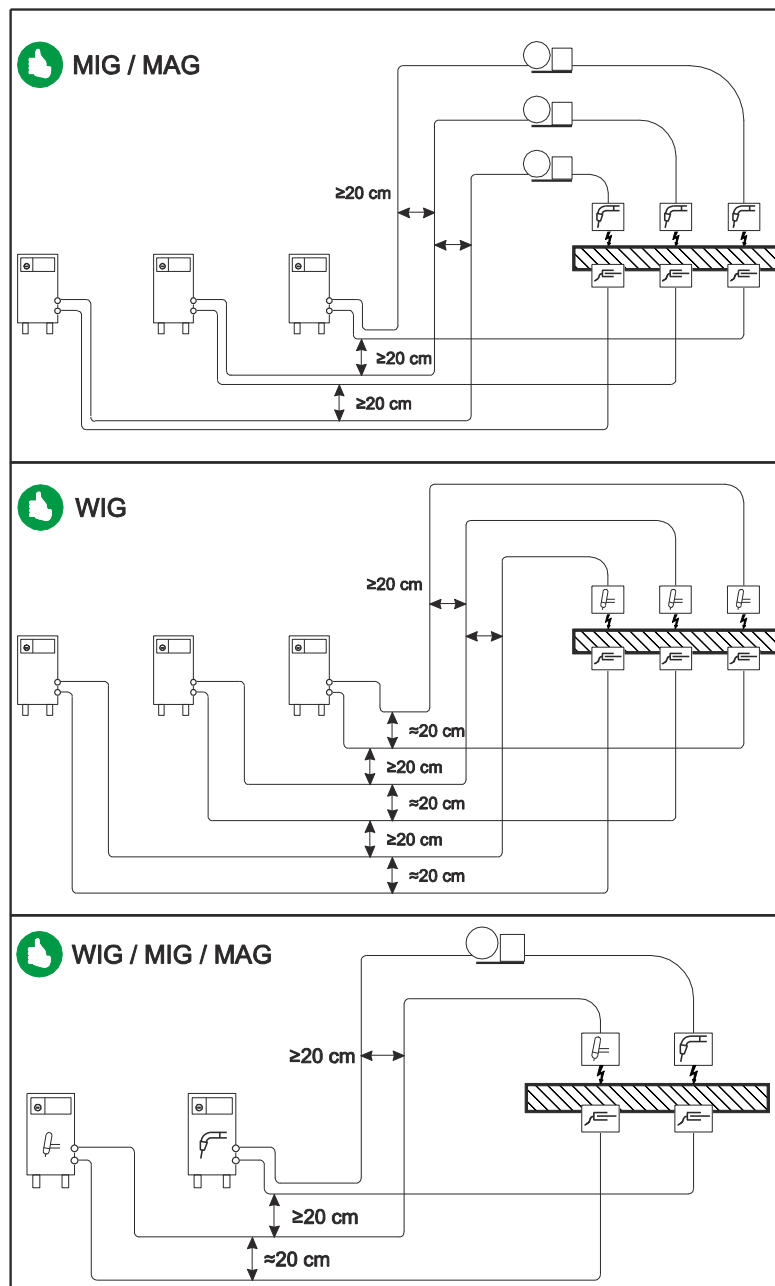

Figure 5-3

NOTE

Use an individual welding lead to the workpiece for each welding machine!

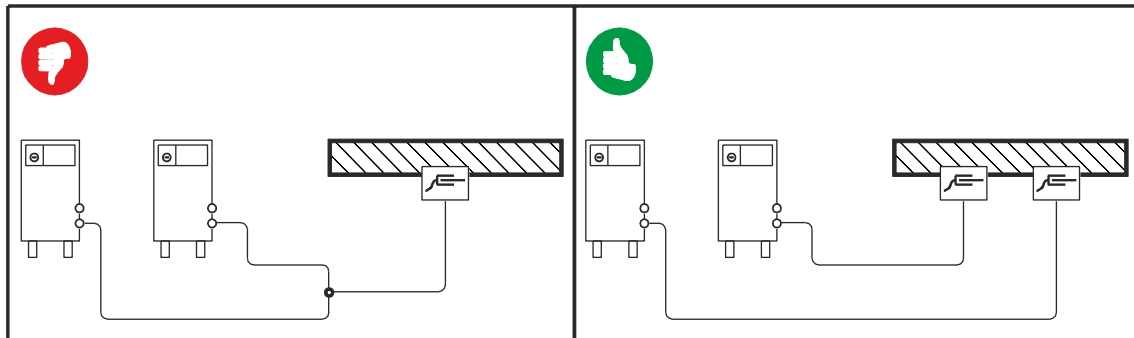

Figure 5-4

NOTE

- Fully unroll welding current leads, torch hose packages and intermediate hose packages. Avoid loops!
- Always keep leads as short as possible!
- Lay any excess cable lengths in meanders.

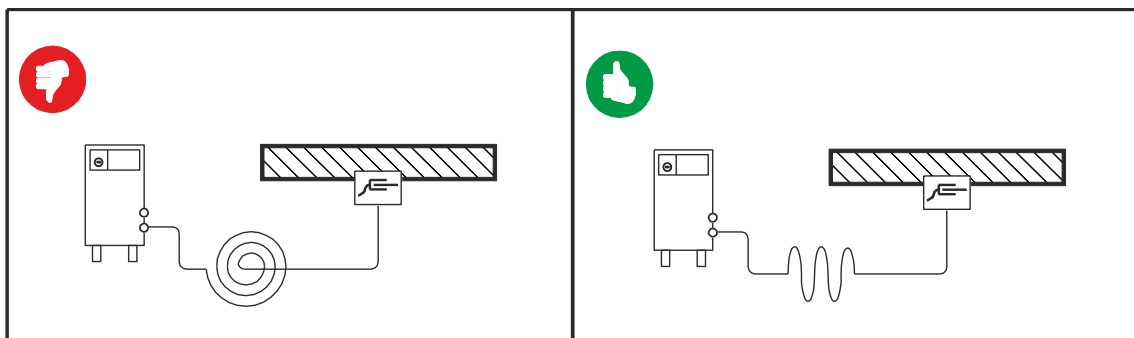

Figure 5-5

5.8 TIG welding

5.8.1 Welding torch and workpiece line connection

CAUTION



Equipment damage due to improperly connected coolant lines!

If the coolant lines are not connected or a gas-cooled welding torch is used, the coolant circuit is interrupted and equipment damage can occur.

- Connect all coolant lines correctly!
- When using a gas-cooled welding torch, add a tube bridge to the coolant circuit (see chapter "Accessories").

NOTE



Prepare welding torch according to the welding task in hand (see operating instructions for the torch).

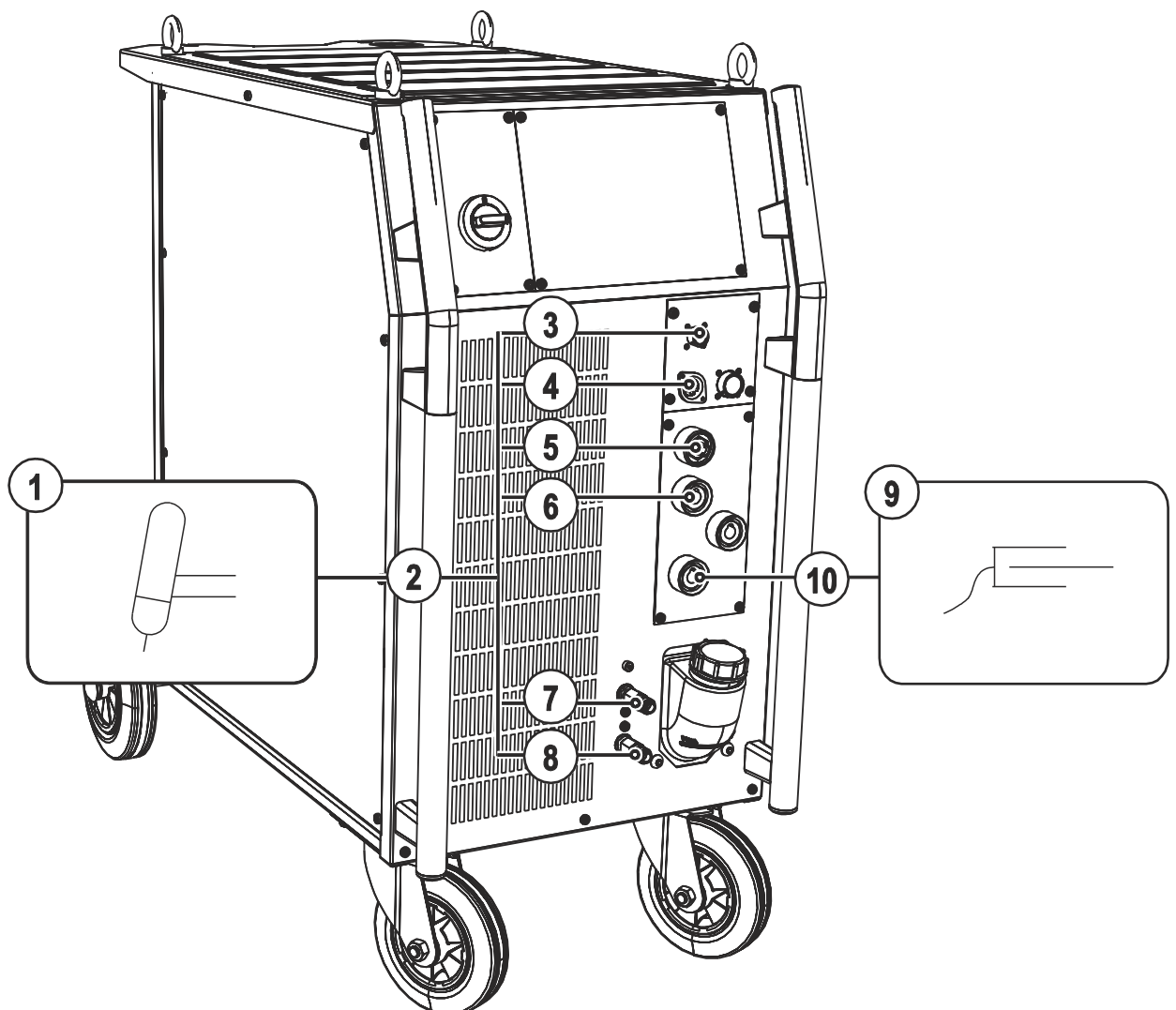

Figure 5-6

Item	Symbol	Description
1		Welding torch
2		Welding torch hose package
3		Connection socket, 8-pole TIG Up/Down or potentiometer torch control lead
4		Connection socket, 5-pole Standard TIG torch control lead
5		G$\frac{1}{4}$" connecting nipple, "-" welding current Shielding gas connection (with yellow insulating cap) for TIG welding torch
6		Connection socket, "-" welding current TIG welding torch connection
7		Quick connect coupling (red) coolant return
8		Quick connect coupling (blue) coolant supply
9		Workpiece
10		Connection socket, "+" welding current Connection for workpiece lead

- Insert the welding current plug on the welding torch into the welding current connection socket and lock by turning to the right.
- Screw welding torch shielding gas connection tightly onto the G $\frac{1}{4}$ " connection nipple, welding current "-".
- Insert control lead plus on the welding torch into the connection socket for the welding torch control lead (5-pole for a standard torch, 8-pole for up/down or potentiometer torches) and tighten.
- Lock connecting nipples of the cooling water tubes into the corresponding quick connect couplings: Return line red to quick connect coupling, red (coolant return) and supply line blue to quick connect coupling, blue (coolant supply).
- Insert the cable plug on the work piece lead into the "+" welding current connection socket and lock by turning to the right.

5.8.1.1 Torch connection options and pin assignments

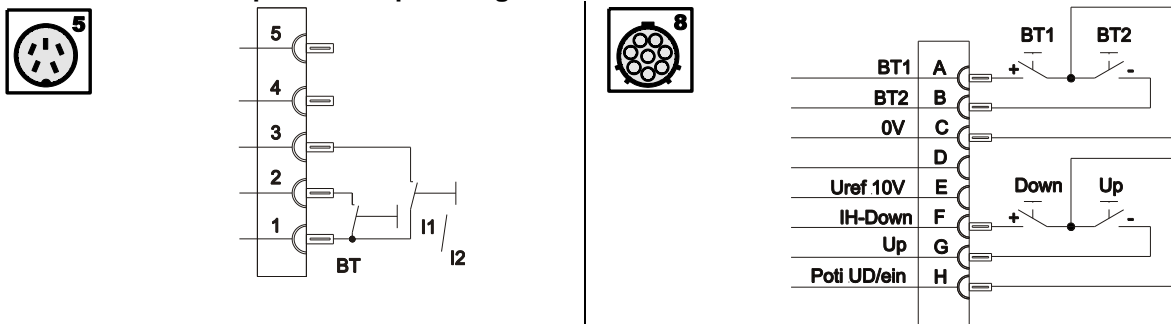

Figure 5-7

5.8.2 Shielding gas supply (shielding gas cylinder for welding machine)

WARNING

**Risk of injury due to improper handling of shielding gas cylinders!
Improper handling and insufficient securing of shielding gas cylinders can cause serious injuries!**

- Secure shielding gas cylinders using the standard fastening elements on the unit (chain/belt)!
- The fastening elements must tightly enclose the shielding gas cylinder!
- Attach the fastening elements within the upper half of the shielding gas cylinder!
- Do not attach any element to the shielding gas cylinder valve!
- Observe the instructions from the gas manufacturer and any relevant regulations concerning the use of compressed air!
- Avoid heating the shielding gas cylinder!

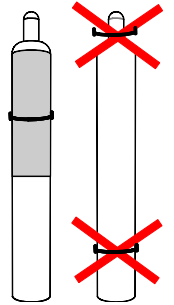
**CAUTION**

Faults in the shielding gas supply.

An unhindered shielding gas supply from the shielding gas cylinder to the welding torch is a fundamental requirement for optimum welding results. In addition, a blocked shielding gas supply may result in the welding torch being destroyed.

- Always re-fit the yellow protective cap when not using the shielding gas connection.
- All shielding gas connections must be gas tight.

NOTE

Before connecting the pressure regulator to the gas cylinder, open the cylinder valve briefly to expel any dirt.

5.8.2.1 Connecting the shielding gas supply

- Place the shielding gas cylinder into the relevant cylinder bracket.
- Secure the shielding gas cylinder using a securing chain.

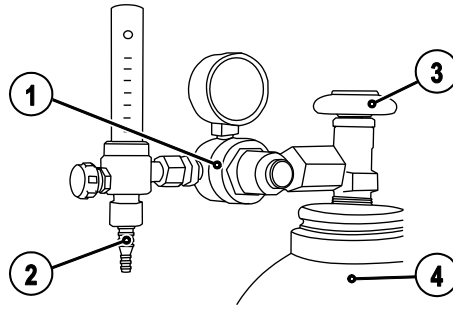

Figure 5-8

Item	Symbol	Description
1		Pressure regulator
2		Shielding gas cylinder
3		Output side of the pressure regulator
4		Cylinder valve

- Tighten the pressure regulator screw connection on the gas bottle valve to be gas-tight.
- Screw gas hose connection crown nut onto the output side of the pressure regulator.
- Fit the gas hose and G1/4" crown nut onto the relevant connection on the welding machine, and fit the wire feed unit (if present on this version).

5.8.2.2 Setting the shielding gas quantity

CAUTION



Electric shocks!

When setting the shielding gas quantity, high voltage ignition pulses or open circuit voltage are applied at the welding torch; these can lead to electric shocks and burning on contact.

- Keep the welding torch electrically insulated from persons, animals or equipment during the setting procedure.

- Press the torch trigger and set the shielding gas quantity with the flow gauge of the pressure regulator.

NOTE



Rule of thumb for the gas flow rate:

Diameter of gas nozzle in mm corresponds to gas flow in l/min.

Example: 7mm gas nozzle corresponds to 7l/min gas flow.



Incorrect shielding gas setting!

If the shielding gas setting is too low or too high, this can introduce air to the weld pool and may cause pores to form.

- Adjust the shielding gas quantity to suit the welding task!

5.8.3 Select welding task

NOTE

No changes can be made to the basic welding parameters during the welding process.

The welding task is selected using the buttons on the machine control on the welding machine. Signal lights (LED) display the welding parameter selection.

Set the welding task in the following order:

Symbol	Description
	Welding process button MMA welding TIG welding
	Operating mode button <i>spotArc</i> spotArc (spot time setting range 0.01 sec. to 20.0 sec.) Non-latched Latched
	TIG pulse welding Automatic TIG automated pulses (frequency and balance)
	Select welding parameters button This button is used to select the welding parameters depending on the welding process and operating mode used.
	Welding parameter setting rotary transducer Setting flows, times and parameters.

5.8.3.1 Welding data display

The following welding parameters can be displayed before (nominal values) or during (actual values) welding.

Parameter	Before welding (nominal values)	During welding (actual values)
Welding current	●	●
Parameter times	●	-
Parameter currents	●	-

5.8.3.2 Expert menu (TIG)

The expert menu includes functions and parameters which are either not set on the machine control, or which do not require regular setting.

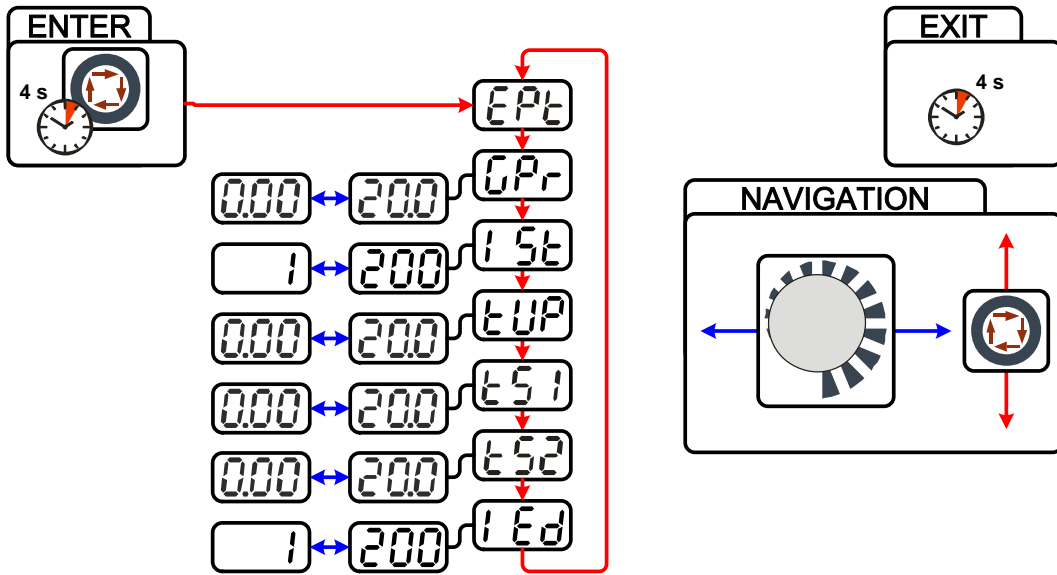

Figure 5-9

Display	Setting/selection
	Expert menu
	Gas pre-flow time Setting range: 0.0 s to 20.0 s (0.1 s increments)
	Ignition current Setting: 1% to 200% (20% ex works, dependent on main current)
	Up-slope time 0.0 s to 20.0 s (1.0 s ex works, 0.1 s increments)
	Slope time tS1 (main current to secondary current) Setting: 0.00 s to 20.0 s (factory setting 0.00 s)
	Slope time tS2 (secondary current to main current) Setting: 0.00 s to 20.0 s (factory setting 0.00 s)
	End-crater current Setting range in percent: 1 % to 200 % depending on main current

NOTE

- ENTER (enter the menu)**
 - Keep the "welding parameters" button pressed for 4 s.
- Navigating in the menu**
 - Parameters are selected by pressing the "welding parameters" button.
 - Set or change the parameters by turning the "welding parameter setting" rotary dial.
- EXIT (leave the menu)**
 - After 4 s, the machine will return automatically to the ready-to-operate status.

5.8.4 Arc ignition

5.8.4.1 HF ignition

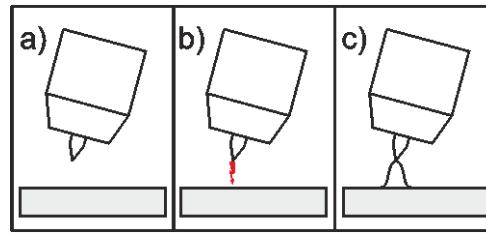

Figure 5-10

The arc is started without contact from high-voltage ignition pulses.

- Position the welding torch in welding position over the workpiece (distance between the electrode tip and workpiece should be approx. 2-3mm).
- Press the torch trigger (high voltage ignition pulses ignite the arc).
- Ignition current flows, and the welding process is continued depending on the operating mode selected.

End the welding process: Release or press the torch trigger depending on the operating mode selected.

5.8.4.2 Liftarc ignition

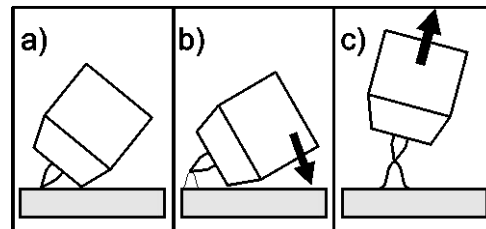

Figure 5-11

The arc is ignited on contact with the workpiece:

- Carefully place the torch gas nozzle and tungsten electrode tip onto the workpiece and press the torch trigger (liftarc current flowing, regardless of the main current set).
- Incline the torch over the torch gas nozzle to produce a gap of approx. 2-3 mm between the electrode tip and the workpiece. The arc ignites and the welding current is increased, depending on the operating mode set, to the ignition or main current set.
- Lift off the torch and swivel to the normal position.

Ending the welding process: Release or press the torch trigger depending on the operating mode selected.

5.8.4.3 Automatic cut-out

NOTE

-  **The automatic cut-out function will be triggered by two conditions during the welding process:**
- During the ignition phase (ignition fault)**
- If there is no welding current within 3s after starting the welding.
- During the welding phase (arc interruption)**
- If the arc is interrupted for longer than 3s.
- In both cases, the welding machine ends the ignition or welding process immediately.**

5.8.5 Function sequences/operating modes

The parameters for the function sequence are set using the “Select welding parameters” button and the “Welding parameter setting” rotary dial.

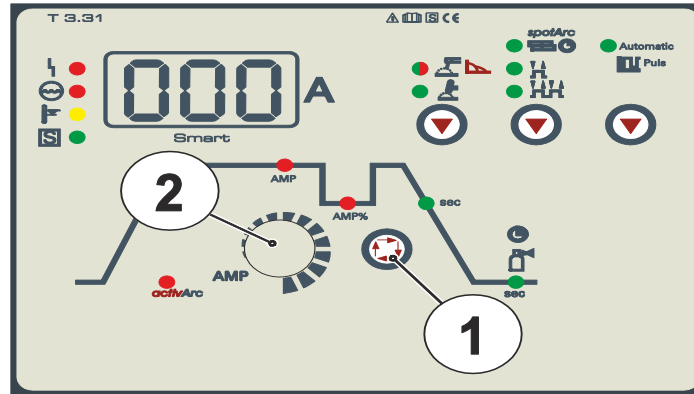

Figure 5-12

Item	Symbol	Description
1		Select welding parameters button This button is used to select the welding parameters depending on the welding process and operating mode used.
2		Welding parameter setting rotary dial Setting currents, times and parameters.

5.8.5.1 Explanation of symbols

Symbol	Meaning
	Press torch trigger 1
	Release torch trigger 1
I	Current
t	Time
	Gas pre-flows
I _{start}	Ignition current
t _{Up}	Up-slope time
t _P	Spot time
AMP	Main current (minimum to maximum current)
AMP%	Secondary current (0% to 100% of AMP)
ts1	TIG pulses: Slop time from main current (AMP) to secondary current (AMP%)
ts2	TIG pulses: Slop time from secondary current (AMP%) to main current (AMP)
t _{Down}	Down-slope time
I _{end}	End-crater current
	Gas post-flows

5.8.5.2 Non-latched mode

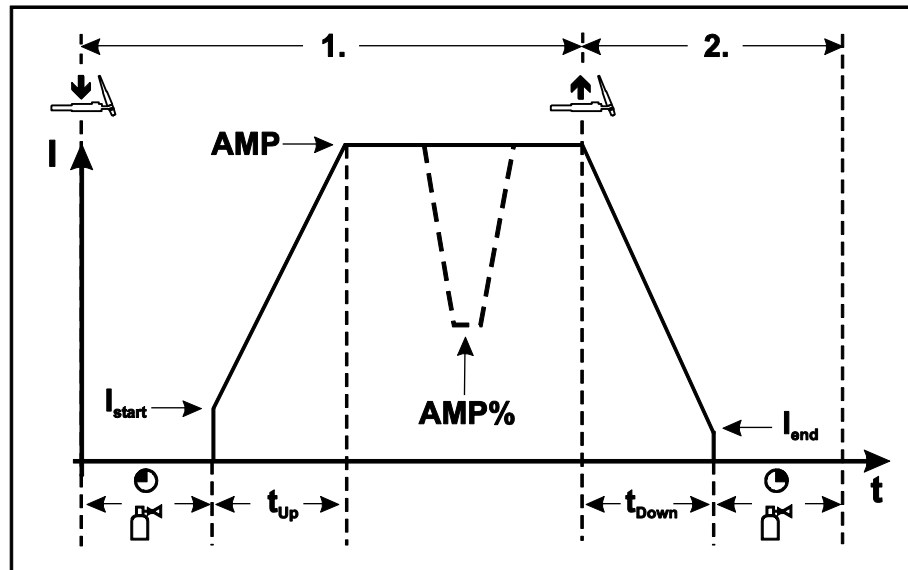

Figure 5-13

1st cycle:

- Press and hold torch trigger 1.
- The gas pre-flow time elapses.
- HF ignition pulses jump from the electrode to the workpiece, the arc ignites.
- The welding current flows and immediately assumes the value set for the ignition current I_{start} .
- HF is switched off.
- The welding current increases with the adjusted up-slope time to the main current AMP.

If torch trigger 2 is pressed in addition to torch trigger 1 during the main current phase, the welding current drops at the slope time set (t_{S1}) to the secondary current AMP%.

After torch trigger 2 is released, the welding current rises at the slope time set (t_{S2}) back to the main current AMP.

2nd cycle:

- Release torch trigger 1.
- The main current falls in the set down-slope time to the end-crater current I_{end} (minimum current).

If the 1st torch trigger is pressed during the down-slope time, the welding current returns to the main current AMP set.

- The main current reaches the end-crater current I_{end} , the arc extinguishes.
- The set gas post-flow time elapses.

NOTE

When the foot-operated remote control RTF is connected, the machine switches automatically to non-latched operation. The up- and down-slopes are switched off.

5.8.5.3 Latched mode

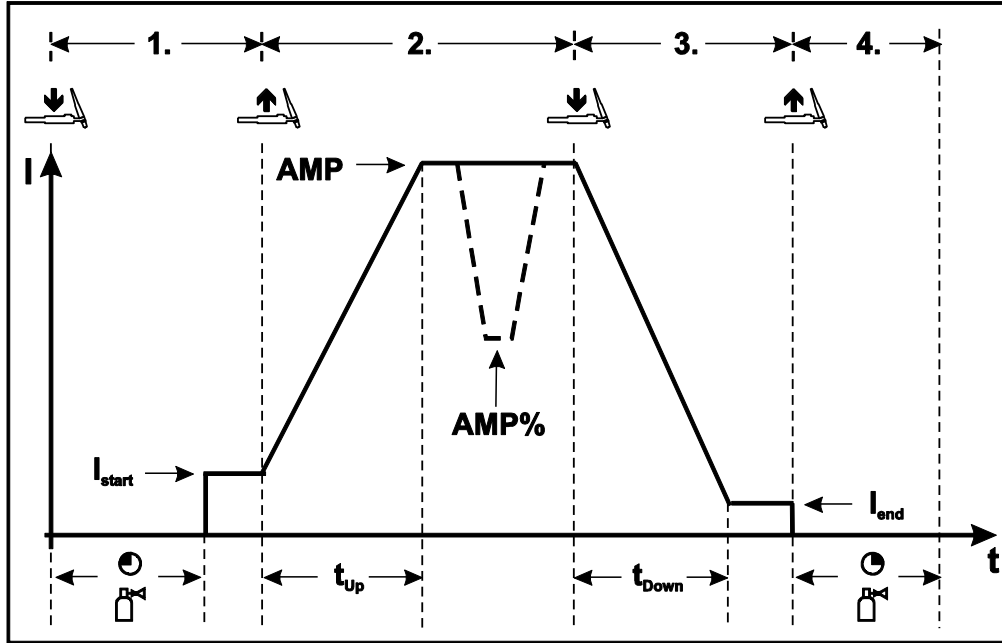

Figure 5-14

Step 1

- Press torch trigger 1, the gas pre-flow time elapses.
- HF ignition pulses jump from the electrode to the workpiece, the arc ignites.
- Welding current flows and immediately assumes the ignition current value set (search arc at minimum setting). HF is switched off.

Step 2

- Release torch trigger 1.
- The welding current increases with the set up-slope time to the main current AMP.

Switching from main current AMP to secondary current AMP%:

- Press torch trigger 2 or
- Tap torch trigger 1

The slope times can be set (see chapter "Advanced settings", section "Setting slope times for secondary current AMP% or pulse edges").

Step 3

- Press torch trigger 1.
- The main current drops with the set down-slope time to the end-crater current I_{end} (minimum current).

Step 4

- Release torch trigger 1, the arc extinguishes.
- The set gas post-flow time begins.

Immediate termination of the welding procedure without down-slope and end-crater current:

- Briefly press the 1st torch trigger (3rd and 4th step).
The current drops to zero and the gas post-flow time begins.

NOTE



When the foot-operated remote control RTF is connected, the machine switches automatically to non-latched operation. The up- and down-slopes are switched off.



To use the alternative welding start (tapping start) a double-digit torch mode (11-x) has to be set at the welding machine control. The number of torch modes available depends on the machine type. For single-digit torch modes (1-x) this function is disabled.

5.8.5.4 TIG spotArc

This process is suitable for tack welding or joint welding of metal sheets made from steel and CrNi alloys up to a thickness of approximately 2.5 mm. Metal sheets of different thicknesses can also be welded on top of one another.

The spot welding operating modes (spotArc/Spotmatic) can be used with two different intervals, i.e. a "long" or "short" interval, which are defined as follows:

Interval	Setting range	Up-/down-slope	Pulsing	AC	Display	Display
Long	0.01–20.0 s (10 ms)	Yes	Yes	Yes		
Short	5–999 ms (1 ms)	No	No	No		

When selecting the spotArc operating mode, the long interval is automatically preselected. When selecting the Spotmatic operating mode, the short interval is automatically preselected. The user can change the interval in the Configuration menu (see chapter "Advanced settings").

Selecting and setting TIG spotArc

Operating element	Action	Result
 		<p>Signal light comes on</p> <p>The spot time can be set for approx. 4 s using the "Welding parameter setting" rotary dial (spot time setting range 0.01 s to 20.0 s)</p>
		Set spot time "tP"
 		<p>The TIG spotArc process is switched on with the pulse variant "TIG automated pulses" by default.</p> <p>Automatic TIG automated pulses (frequency and balance)</p>

NOTE



The up-slope and down-slope times should be set to "0" to achieve an effective result.

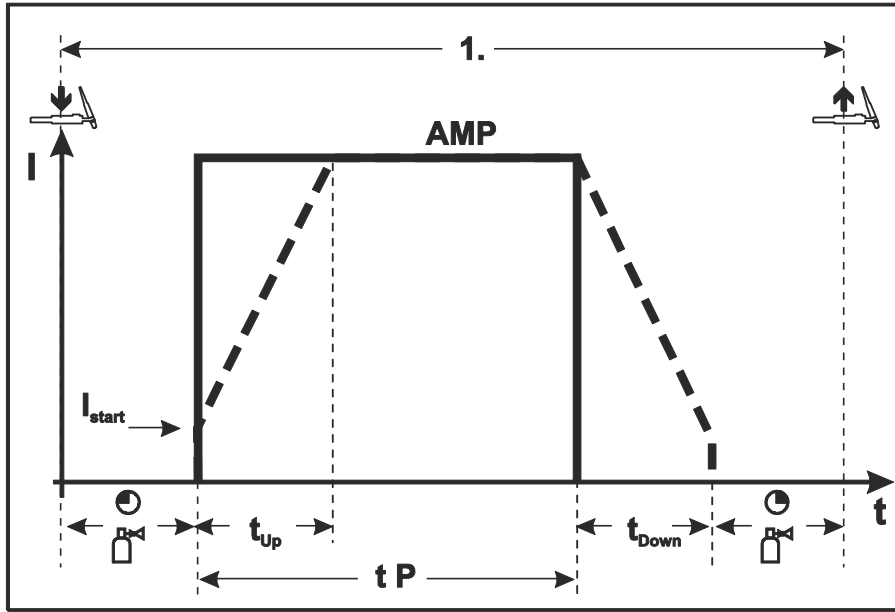

Figure 5-15

As an example the process is shown with HF ignition. Arc ignition with lift arc is also possible, however (see chapter "Arc ignition").

Sequence:

- Press and hold torch trigger 1.
- The gas pre-flow time elapses.
- HF ignition pulses jump from the electrode to the workpiece, the arc ignites.
- The welding current flows and immediately assumes the value set for the ignition current I_{start} .
- HF is switched off.
- The welding current increases in the adjusted up-slope time to the main current AMP.

NOTE

The process ends when the set spotArc time elapses or if the torch trigger is released prematurely.

5.8.5.5 Spotmatic

NOTE

 **This function must be enabled before use, see "Advanced settings" chapter.**

In contrast to the spotarc operating mode, the arc ignites not by pressing the torch trigger as is usual, but by shortly touching the tungsten electrode against the workpiece. The torch trigger is used for process activation. The process can be activated separately for each spot or permanently (see chapter "Advanced settings"):

- **Separate process activation:**
The welding process has to be reactivated for every arc ignition by pressing the torch trigger.
- **Permanent process activation:**
The welding process is activated by pressing the torch trigger once. The following arc ignitions are initiated by shortly touching the tungsten electrode against the workpiece.

NOTE

 **Selection and adjustment are made in the same way as with spotArc operating mode (see chapter TIG spotArc).**

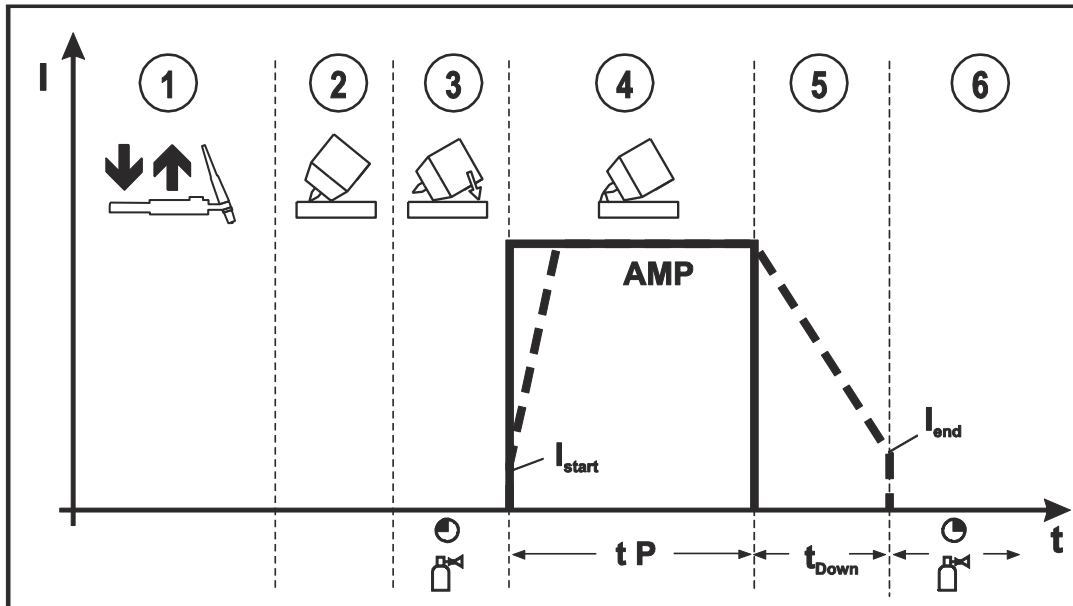

Figure 5-16

As an example the process is shown with HF ignition. Arc ignition with lift arc is also possible, however (see chapter "Arc ignition").

Select the process activation type (see chapter "Advanced settings").

Up- and down-slope times possible for long setting range of the spot time (0.01 s - 20.0 s) only.

- ① Press and release torch trigger (tap) to activate the welding process.
- ② Touch the torch gas nozzle and tungsten electrode tip carefully against the workpiece.
- ③ Incline the torch over the torch gas nozzle until there is a gap of approx. 2-3 mm between the electrode tip and the workpiece. Shielding gas flows in the set gas pre-flow time. The arc ignites and the previously set ignition current (I_{start}) flows.
- ④ The main current phase ends when the set spotArc time expires.
- ⑤ The welding current drops in the set down-slope time to the end current (I_{end}).
- ⑥ The gas post-flow time expires and the welding process ends.

Press and release torch trigger (tap) to reactivate the welding process (only for separate process activation). Touching the torch with the tungsten electrode tip again against the workpiece will initiate the next welding processes.

5.8.5.6 Non-latched operation, version C

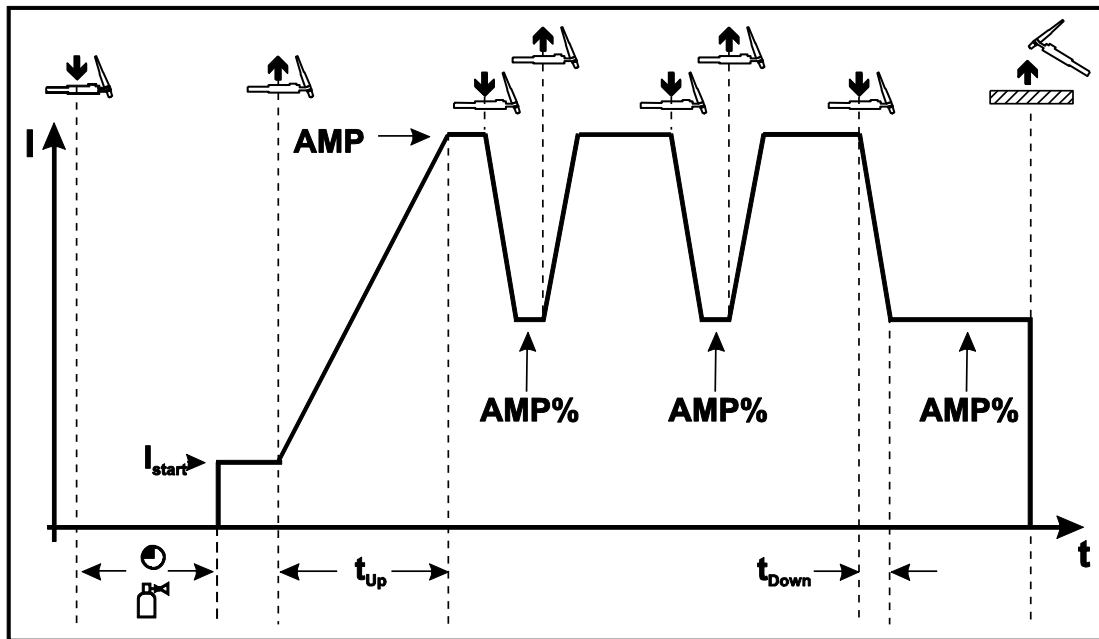

Figure 5-17

1st cycle

- Press torch trigger 1, the gas pre-flow time elapses.
- HF ignition pulses jump from the electrode to the workpiece, the arc ignites.
- Welding current flows and immediately adopts the ignition current value set (search arc at minimum setting). HF is switched off.

2nd cycle

- Release torch trigger 1.
- The welding current increases in the set up-slope time to the main current AMP.

NOTE

- Pressing torch trigger 1 starts the slope (t_{S1}) from main current AMP to secondary current AMP%. Releasing the torch trigger starts the slope (t_{S2}) from the secondary current AMP% back to the main current AMP. This process can be repeated as often as required.

The welding process is ended by the arc interruption in the secondary current (removing the torch from the workpiece until the arc is extinguished).

The slope times can be set (see chapter "Advanced settings", section "Setting slope times for secondary current AMP% or pulse edges").
- This operating mode needs to be activated (see chapter "Advanced settings" in the "TIG non-latched operating mode, C version") section.

5.8.5.7 Automated pulses

NOTE

The machines have an integrated pulse device.
With pulses, the machine switches back and forth between the pulse current (main current) and pause current (secondary current).

The automated pulses are used with tacking and spot welding of workpieces in particular. An oscillation in the molten pool is produced by the current-dependent pulse frequency and balance, which positively influences the ability to bridge the air gap. The pulse parameters required are automatically specified by the machine control.

Operating element	Action	Result
 		Select TIG automated pulses Press the "TIG pulses" button until the TIG automated pulses signal light Automatic comes on

5.8.5.8 TIG pulses – non-latched operation

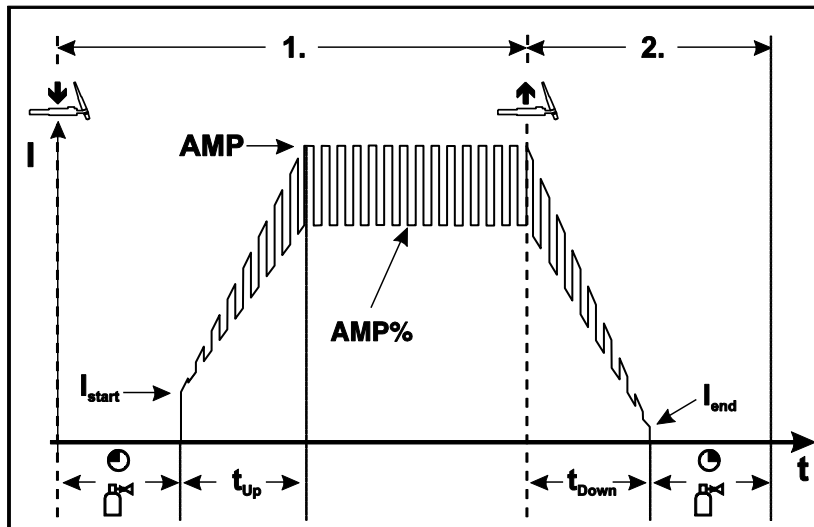

Figure 5-18

5.8.5.9 TIG pulses - latched operation

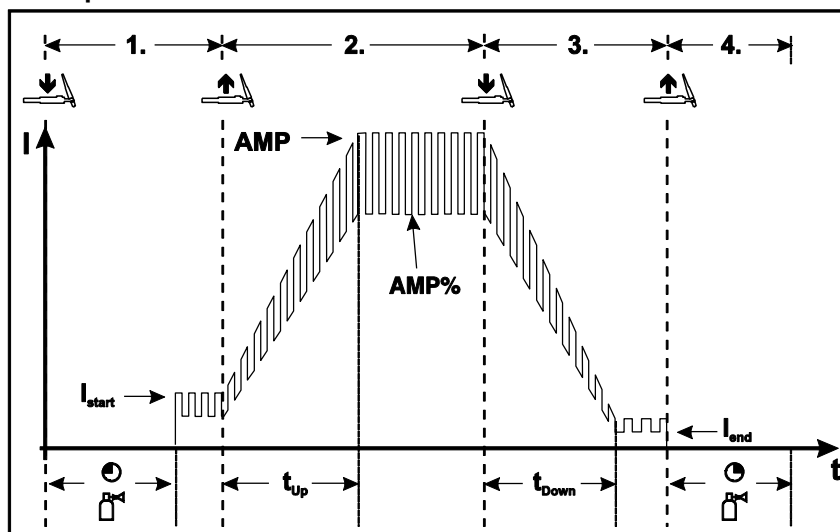

Figure 5-19

5.8.6 TIG *activArc* welding

The EWM *activArc* process, thanks to the highly dynamic controller system, ensures that the power supplied is kept virtually constant in the event of changes in the distance between the welding torch and the weld pool, e.g. during manual welding. Voltage losses as a result of a shortening of the distance between the torch and molten pool are compensated by a current rise (ampere per volt - A/V), and vice versa. This helps prevent the tungsten electrode sticking in the molten pool and the tungsten inclusions are reduced. This is particularly useful in tacking and in spot welding.

Operating element	Action	Result	Display
	n x	Select <i>activArc</i> parameter Press until activArc LED flashes	-
		• Switch parameter on	
		• Switch parameter off	

Parameter setting

The *activArc* parameter (control) can be adjusted specifically for the welding task (panel thickness).

- Preset with: TIG *activArc* welding
- Enter the menu (ENTER) Keep the runtime parameter button pressed for 4 s.
- Leave the menu (EXIT) Keep the runtime parameter button pressed for 4 s.

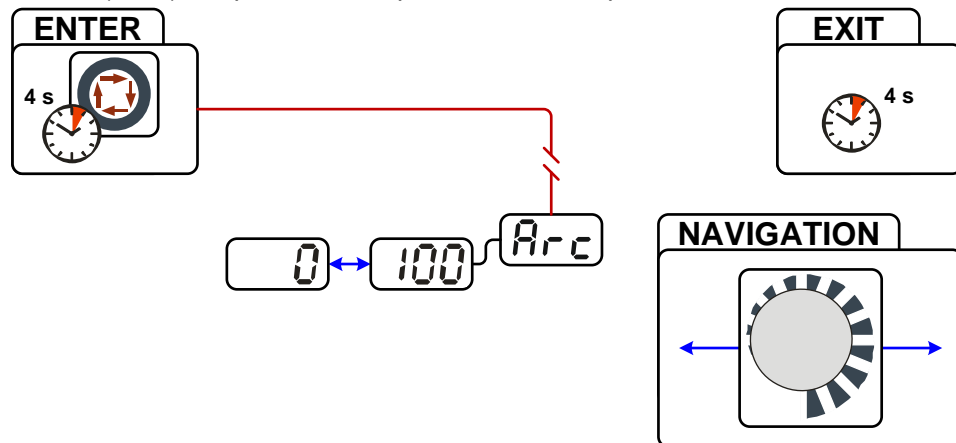

Figure 5-20

Display	Setting/selection
	activArc parameter Setting: 0 to 100 (factory setting 50)

5.8.7 Welding torch (operating variants)

Different torch versions can be used with this machine.

Functions on the operating elements, such as torch triggers (TT), rockers or potentiometers, can be modified individually via torch modes.

Explanation of symbols for operating elements:

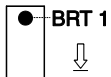
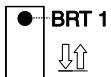
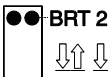
Symbol	Description
	Press torch trigger
	Tap torch trigger
	Tap and press torch trigger

5.8.7.1 Tap torch trigger (tapping function)

NOTE



Swiftly tap the torch trigger to change the function.

The torch mode set determines the operating mode of the tapping function.

5.8.7.2 Torch mode and up/down speed setting

The user has the modes 1 to 6 and modes 11 to 16 available. Modes 11 to 16 include the same function options as 1 to 6, but without tapping function for the secondary current.

The function options in the individual modes can be found in the tables for the corresponding torch types. The welding process can of course be switched on and off in all modes using torch trigger 1 (TT 1).

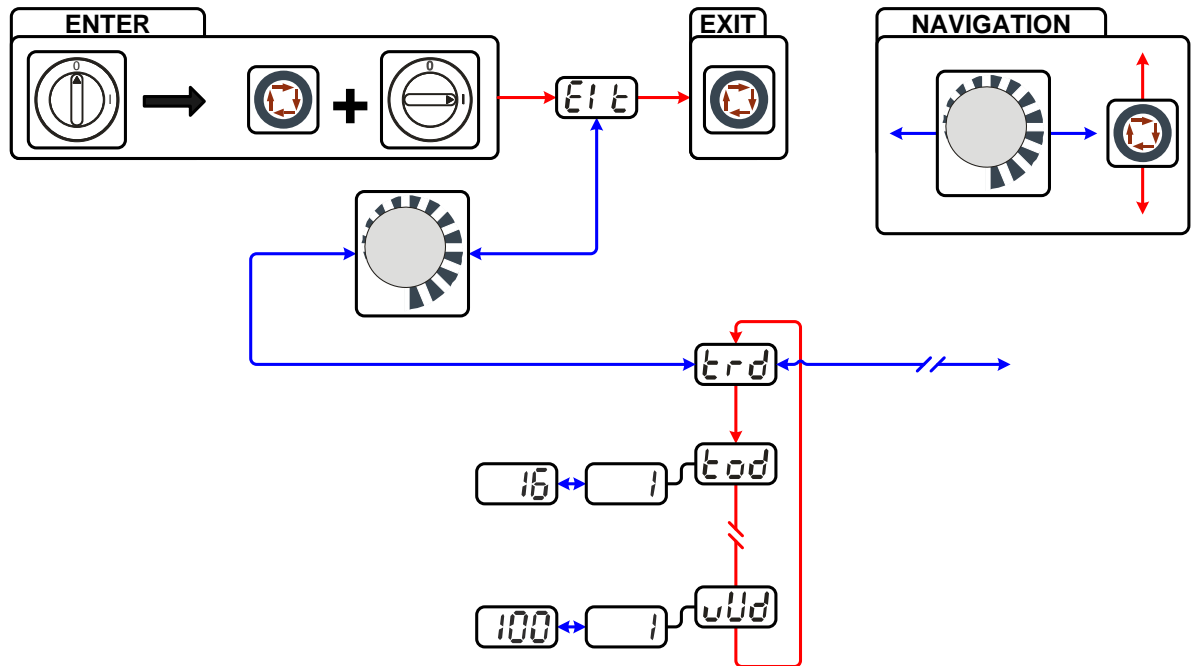

Figure 5-21

Display	Setting/selection
	Exit the menu Exit
	Torch configuration menu Set welding torch functions
	Torch mode (factory setting 1)
	Up-/Down speed Increase value = rapid current change (factory setting 10) Reduce value = slow current change

NOTE

Only the modes listed are suitable for the corresponding torch types.

5.8.7.3 Standard TIG torch (5-pole)



Standard torch with one torch trigger:











Diagram	Operating elements	Explanation of symbols
		BRT1 = Torch trigger 1 (welding current on/off; secondary current via tapping function)
Functions	mode	Operating elements
Welding current On/Off	1 (factory-set)	
Secondary current (Latched mode)		

Standard torch with two torch triggers:

Diagram	Operating elements	Explanation of symbols
		BRT1 = torch trigger 1 BRT2 = torch trigger 2
Functions	mode	Operating elements
Welding current On/Off	1 (factory-set)	
Secondary current		
Secondary current (tapping mode) / (latched mode)		
Welding current On/Off	3	
Secondary current (tapping mode) / (latched mode)		
Up function		
Down function		

Standard torch with one rocker (MG rocker, two torch triggers)

Diagram	Operating elements	Explanation of symbols
		BRT 1 = torch trigger 1 BRT 2 = torch trigger 2

Functions	mode	Operating elements
Welding current On/Off	1 (factory-set)	 BRT 1
Secondary current		 BRT 2
Secondary current (tapping mode) / (latched mode)		 BRT 1
Welding current On/Off	2	 BRT 1 + BRT 2
Secondary current (tapping mode)		 BRT 1 + BRT 2
Up function		 BRT 1
Down function		 BRT 2
Welding current On/Off	3	 BRT 1
Secondary current (tapping mode) / (latched mode)		 BRT 1
Up function		 BRT 2
Down function		 BRT 2

5.8.7.4 TIG up/down torch (8-pole)

Up/down torch with one torch trigger

Diagram	Operating elements	Explanation of symbols
		TT 1 = torch trigger 1

Functions	Mode	Operating elements
Welding current on/off	1 (factory-set)	
Secondary current (tapping mode) / (latched mode)		
Increase welding current, infinite adjustment (up function)		
Reduce welding current, infinite adjustment (down function)		
Welding current on/off	2	
Secondary current (tapping mode)		
Welding current on/off	4	
Secondary current (tapping mode) / (Latched mode)		
Increase welding current by an increment (see chapter "Setting the first increment in modes 4 and 14")		
Reduce welding current by an increment (see chapter "Setting the first increment in modes 4 and 14")		

Up/down torch with two torch triggers

Diagram	Operating elements	Explanation of symbols
		TT 1 = torch trigger 1 (left) TT 2 = torch trigger 2 (right)

Functions	Mode	Operating elements
Welding current on/off	1 (factory-set)	
Secondary current		
Secondary current (tapping mode) / (latched mode)		
Increase welding current, infinite adjustment (up function)		
Reduce welding current, infinite adjustment (down function)		
Welding current on/off	2	
Secondary current		
Secondary current (tapping mode)		
Welding current on/off	4	
Secondary current		
Secondary current (tapping mode)		
Increase welding current by an increment (see chapter "Setting the first increment in modes 4 and 14")		
Reduce welding current by an increment (see chapter "Setting the first increment in modes 4 and 14")		
Gas test	4	

5.8.7.5 Potentiometer torch (8-pole)

NOTE

The welding machine needs to be configured for operation with a potentiometer torch (see chap. "Configuring TIG potentiometer torch")

Potentiometer torch with one torch trigger:

Diagram	Operating elements	Explanation of symbols
		BRT 1 = torch trigger 1

Functions	Mode	Operating elements
Welding current On/Off	3	
Secondary current (tapping mode)		
Increase welding current, infinite adjustment		
Reduce welding current, infinite adjustment		

Potentiometer torch with two torch triggers:

Diagram	Operating elements	Explanation of symbols
		BRT 1 = torch trigger 1 BRT 2 = torch trigger 2

Functions	Mode	Operating elements
Welding current On/Off	3	
Secondary current		
Secondary current (tapping mode)		
Increase welding current, infinite adjustment		
Reduce welding current, infinite adjustment		

5.8.7.6 Configuring the TIG potentiometer torch connection

DANGER



Risk of injury due to electrical voltage after switching off!
Working on an open machine can lead to fatal injuries!
Capacitors are loaded with electrical voltage during operation. Voltage remains present for up to four minutes after the mains plug is removed.

1. Switch off machine.
2. Remove the mains plug.
3. Wait for at last 4 minutes until the capacitors have discharged!

WARNING



Risk of accidents if these safety instructions are not observed!
Non-observance of these safety instructions is potentially fatal!

- Carefully read the safety information in this manual!
- Observe the accident prevention regulations in your country.
- Inform persons in the working area that they must observe the regulations!

CAUTION



Test!
Before re-commissioning, it is essential that an "inspection and test during operation" is carried out conforming to IEC / DIN EN 60974-4 "Arc welding devices - inspection and testing during operation"!

- For detailed instructions, please see the standard operating instructions for the welding machine.

When connecting a potentiometer torch, jumper JP27 on PCB T320/1 inside the welding machine should be unplugged.

Welding torch configuration	Setting
Prepared for TIG standard or up/down torch (factory setting)	<input checked="" type="checkbox"/> JP27
Prepared for potentiometer torches	<input type="checkbox"/> JP27

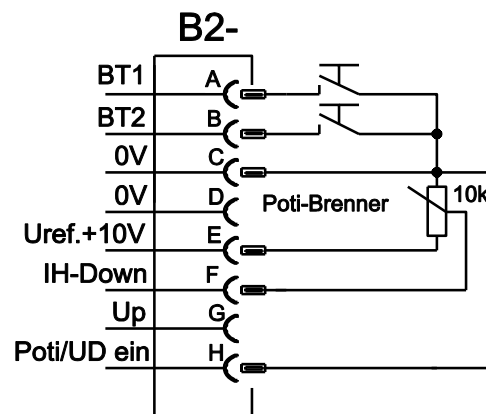

Figure 5-22

NOTE



For this torch type the welding machine has to be set to torch mode 3, see chapter "Setting torch mode and Up/Down speed".

5.8.7.7 Setting the first increment

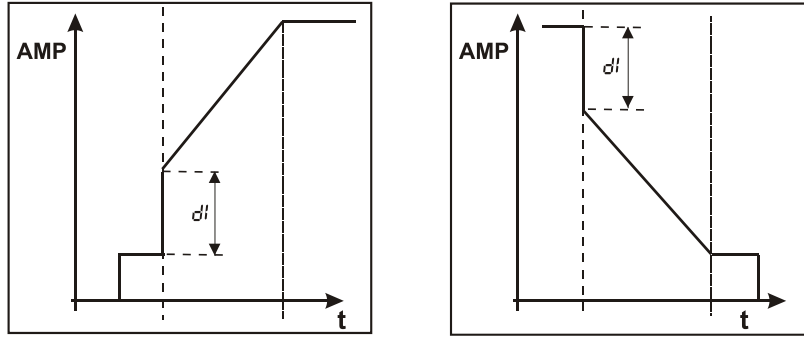

Figure 5-23

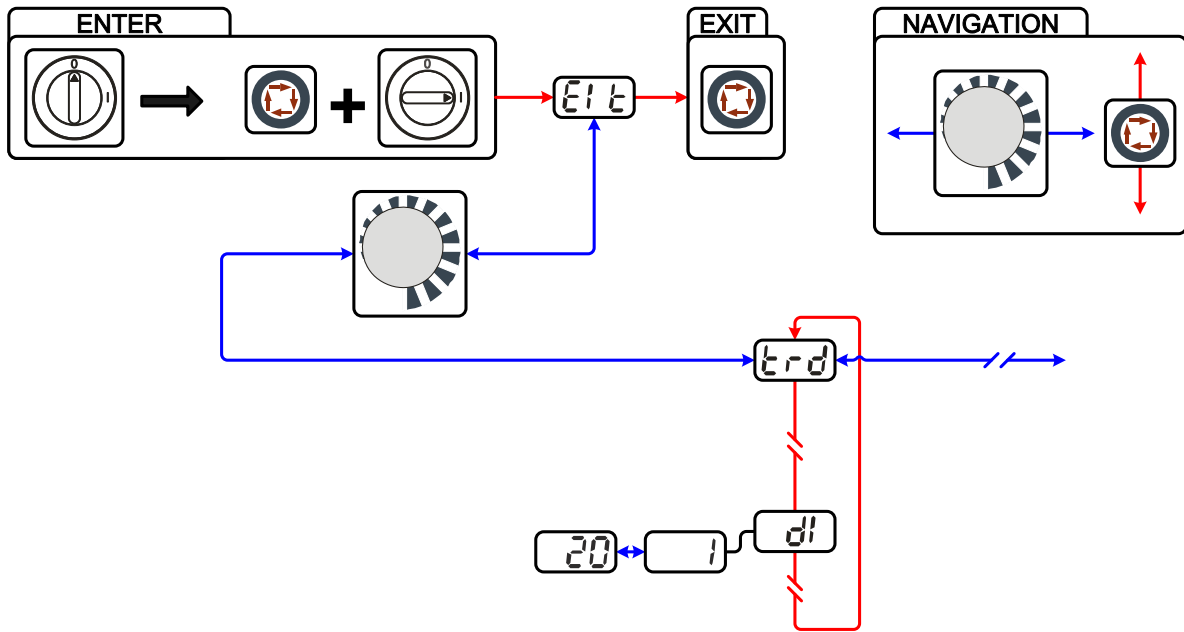

Figure 5-24

Display	Setting/selection
	Exit the menu Exit
	Torch configuration menu Set welding torch functions
	Setting the first increment Setting: 1 to 20 (factory setting 1)

NOTE



This function is only available when using up/down torches in modes 4 and 14!

5.9 MMA welding

⚠ CAUTION



Risk of being crushed or burnt.

When replacing spent or new stick electrodes

- Switch off machine at the main switch
- Wear appropriate safety gloves
- Use insulated tongs to remove spent stick electrodes or to move welded workpieces and
- Always put the electrode holder down on an insulated surface.



Shielding gas connection!

During MMA welding open circuit voltage is applied at the shielding gas connection (G $\frac{1}{4}$ " connecting nipple).

- Place yellow insulating cap on the G $\frac{1}{4}$ " connection nipple (protects against electrical voltage and dirt).

5.9.1 Connecting the electrode holder and workpiece lead

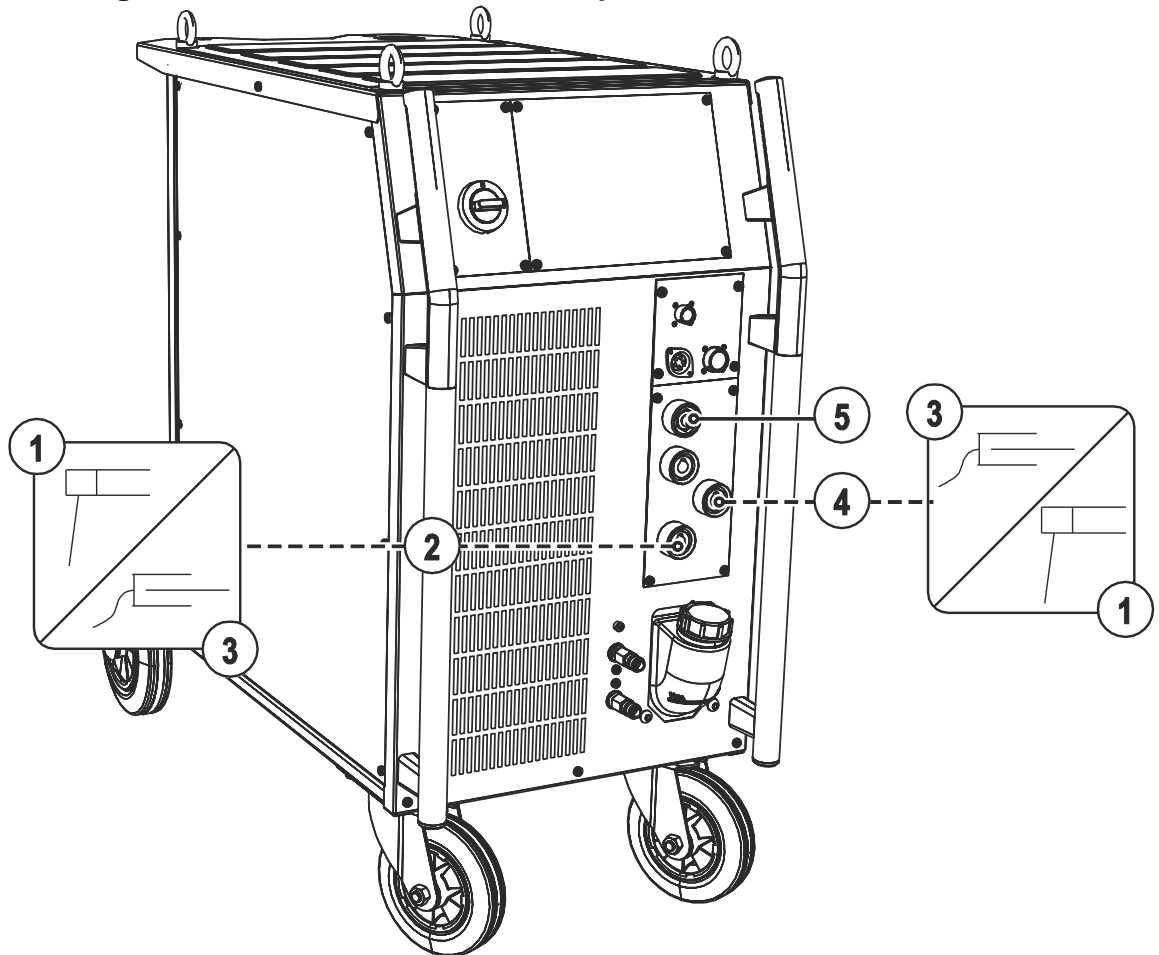





Figure 5-25

Item	Symbol	Description
1		Electrode holder
2		Connection socket, "-" welding current Electrode holder connection
3		Workpiece
4		Connection socket, "+" welding current Connection for workpiece lead

- Insert cable plug of the electrode holder into either the "+" or "-" welding current connection socket and lock by turning to the right.
- Insert cable plug of the workpiece lead into either the "+" or "-" welding current connection socket and lock by turning to the right.

NOTE



Polarity depends on the instructions from the electrode manufacturer given on the electrode packaging.

5.9.2 Select welding task

Operating element	Action	Result
		Select MMA welding process The signal light lights up in green
		Set welding current

5.9.2.1 Hotstart current and Hotstart time

The hotstart device improves the ignition of the stick electrodes using an increased ignition current.

- a) = Hotstart time
- b) = Hotstart current
- I = Welding current
- t = Time

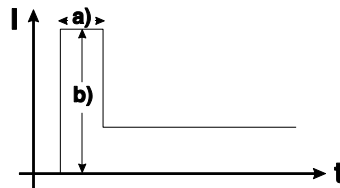

NOTE

- ENTER (enter the menu)**
 - Keep the "welding parameters" button pressed for 4 s.
- Navigating in the menu**
 - Parameters are selected by pressing the "welding parameters" button.
 - Set or change the parameters by turning the "welding parameter setting" rotary dial.
- EXIT (leave the menu)**
 - After 4 s, the machine will return automatically to the ready-to-operate status.

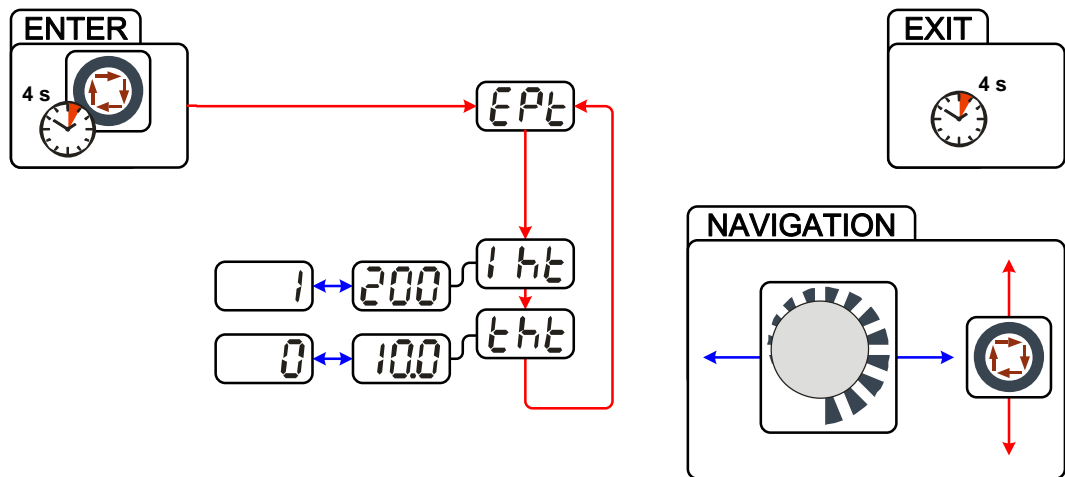

Figure 5-26

Display	Setting/selection
	Hotstart current Hotstart current setting
	Hotstart time Hotstart time setting

5.9.2.2 Arcforce

Shortly before the electrode threatens to stick, the arcforcing device sets an increased current designed to prevent the electrode sticking.

Operating element	Action	Result	Displays
		Select arcforcing welding parameter The signal light lights up in red	
		Set arcforcing -40 = low current increase > soft arc 0 = default setting +40 = high current increase > aggressive arc	

5.9.2.3 Antistick

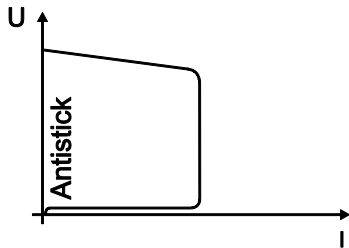

Anti-stick prevents the electrode from annealing.

If the electrode sticks in spite of the Arcforce device, the machine automatically switches over to the minimum current within about 1 second to prevent the electrode from overheating. Check the welding current setting and correct according to the welding task!

Figure 5-27

5.10 Remote control

NOTE



Insert the remote control control cable into the 19-pole connection socket for remote control connection and lock.

5.10.1 Manual remote control RT1 19POL

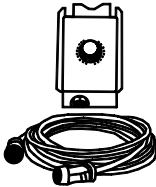

Functions

- Infinitely adjustable welding current (0% to 100%) depending on the preselected main current on the welding machine.

5.10.2 RTG1 19POL manual remote control

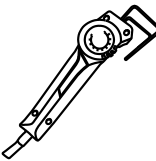

Functions

- Infinite setting of the welding current (0% to 100%) depending on the main current preselected at the welding machine

5.10.3 Manual remote control RTP1 19POL

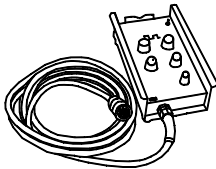

Functions

- TIG/MMA
- Infinitely adjustable welding current (0% to 100%) depending on the preselected main current on the welding machine.
- Pulse/spot/normal
- Pulse, spot and break times are infinitely adjustable.

5.10.4 Manual remote control RTP2 19POL

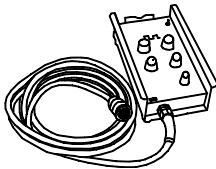

Functions

- TIG/MMA.
- Infinitely adjustable welding current (0% to 100%) depending on the preselected main current on the welding machine.
- Pulse/spot/normal
- Frequency and spot times infinitely adjustable.
- Coarse adjustment of the cycle frequency.
- Pulse/pause ratio (balance) adjustable from 10% to 90%.

5.10.5 RTP3 spotArc 19POL manual remote control

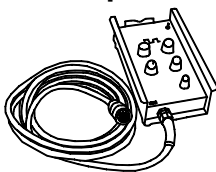

Functions

- TIG / MMA.
- Infinitely adjustable welding current (0% to 100%) depending on the preselected main current on the welding machine.
- Pulse / SpotArc spots / normal
- Frequency and spot time infinitely adjustable.
- Coarse adjustment of the pulse frequency.
- Pulse/pause ratio (balance) adjustable from 10% to 90%.

5.10.6 Foot-operated remote control RTF1 19POL

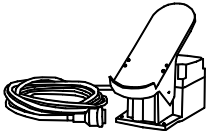

Functions

- Infinitely adjustable welding current (0% to 100%) depending on the preselected main current on the welding machine.
- Start/stop welding operation (TIG)

ActivArc welding is not possible in combination with the foot-operated remote control.

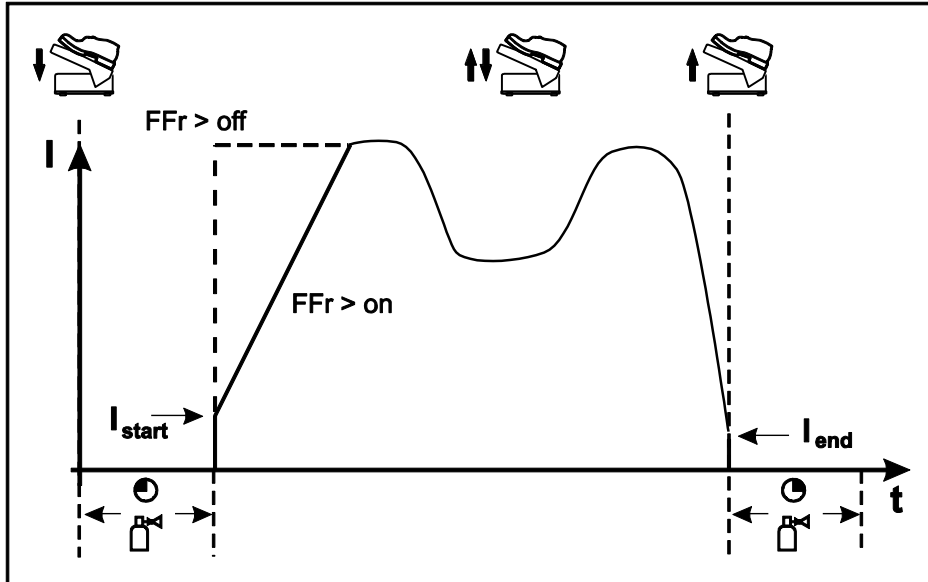

Figure 5-28

Symbol	Meaning
	Actuate foot-operated remote control (start welding process)
	Operate foot-operated remote control (set welding current according to application)
	Release foot-operated remote control (end welding process)
FFr	RTF ramp function on Welding current runs in a ramp function at the specified main current off Welding current goes immediately to the specified main current

5.10.6.1 Ramp function foot-operated remote control RTF 1

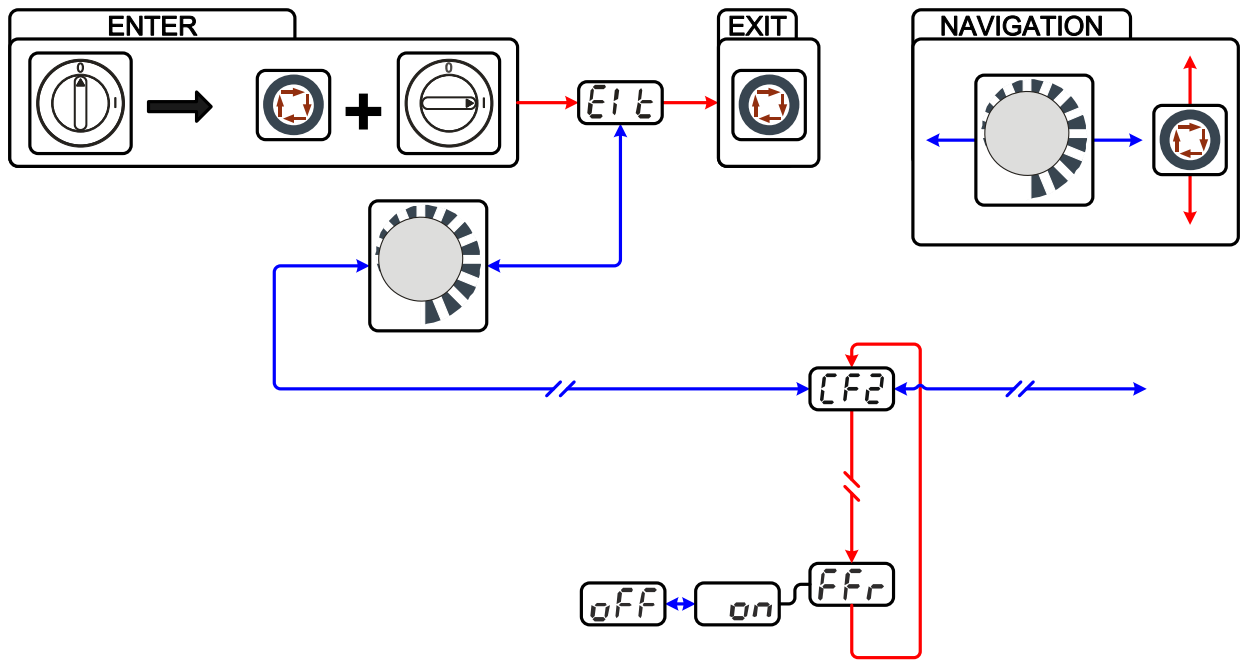

Figure 5-29

Display	Setting/selection
	Exit the menu Exit
	Machine configuration (part two) Settings for machine functions and parameter display
	Ramp function Remote control RTF 1 The ramp function can be switched on and off
	Switch on Switching on machine function
	Switch off Switching off machine function

5.10.7 Foot-operated remote control RTF2 19POL 5m



Functions

- Infinitely adjustable welding current (0% to 100%) depending on the preselected main current on the welding machine.
- Start/stop welding operation (TIG)

ActivArc welding is not possible in combination with the foot-operated remote control.

5.11 Interfaces for automation

CAUTION



Damage to the machine due to improper connection!

Unsuitable control leads or incorrect connection of input and output signals can cause damage to the machine.

- Only use shielded control leads!
- If the machine is to be operated with control voltages connection via suitable isolation amplifiers is required!
- To control the main or secondary current via control voltages, the relevant inputs must be enabled (see specification for activation of control voltage).

5.11.1 Remote control connection socket, 19-pole

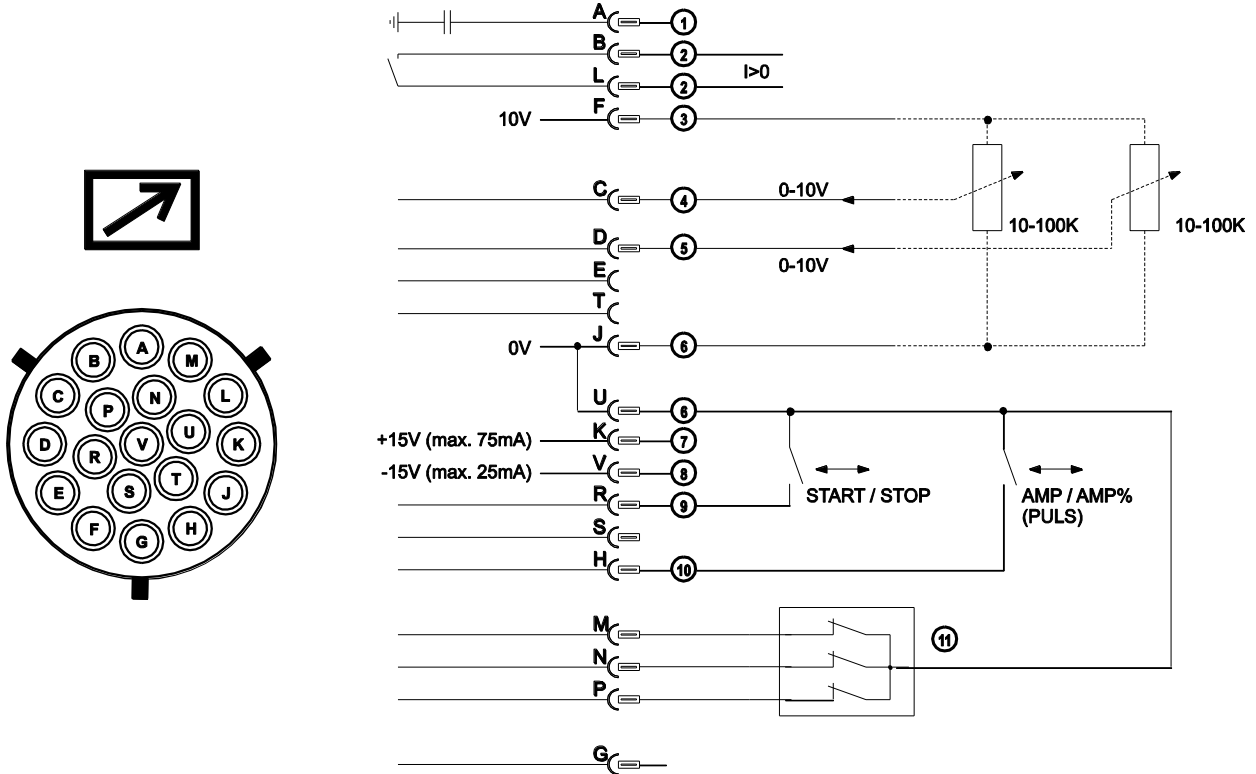
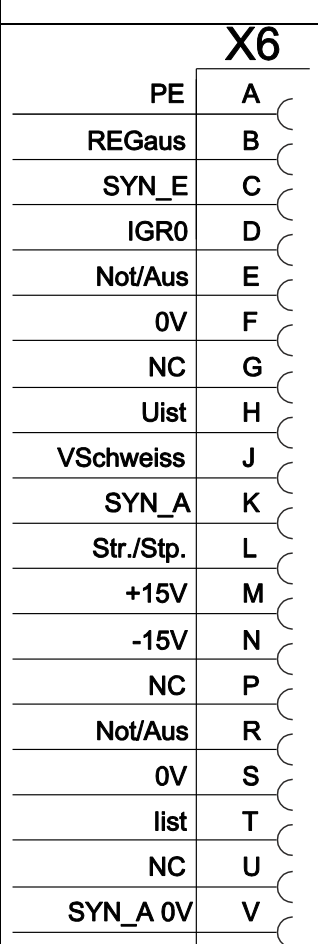

Figure 5-30

Pos.	Pin	Signal shape	Designation
1	A	Output	Connection for cable screen (PE)
2	B/L	Output	Current flows signal $I > 0$, galvanically isolated (max. $\pm 15V/100mA$)
3	F	Output	Reference voltage for potentiometer 10V (max. 10mA)
4	C	Input	Control value specification for main current, 0-10V (0V = I_{min} , 10V = I_{max})
5	D	Input	Control value specification for secondary current, 0-10V (0V = I_{min} , 10V = I_{max})
6	J/U	Output	Reference 0V
7	K	Output	Power supply +15V, max. 75mA
8	V	Output	Power supply -15V, max. 25mA
9	R	Input	Start/Stop welding current
10	H	Input	Switching between main and secondary welding currents (pulses)
11	M/N/P	Input	Activation of control voltage specification Set all 3 signals to reference potential 0V to activate external control voltage specification for main and secondary currents
12	G	Output	Measured value $I_{SETPOINT}$ (1V = 100A)

5.11.2 TIG interface for mechanised welding
NOTE

 These accessory components can be retrofitted as an option, see Accessories chapter.

Pin	Signal shape	Designation	Diagram
A	Output	PE Connection for cable screen	 <p>X6</p> <p>PE A</p> <p>REGaus B</p> <p>SYN_E C</p> <p>IGRO D</p> <p>Not/Aus E</p> <p>0V F</p> <p>NC G</p> <p>Uist H</p> <p>VSchweiss J</p> <p>SYN_A K</p> <p>Str./Stp. L</p> <p>+15V M</p> <p>-15V N</p> <p>NC P</p> <p>Not/Aus R</p> <p>0V S</p> <p>list T</p> <p>NC U</p> <p>SYN_A 0V V</p>
B	Output	REGaus For servicing purposes only	
C	Input	SYN_E Synchronisation for master/slave operation	
D	Input (no c.)	IGRO Current flows signal I>0 (maximum load 20mA / 15V) 0V = welding current flowing	
E	Input	Not/Aus Emergency stop for higher level shut-down of the power source. To use this function, jumper 1 must be unplugged on PCB T320/1 in the welding machine. Contact open = welding current off	
R	Output		
F	Output	0V Reference potential	
G	-	NC Not assigned	
H	Output	Uist Actual welding voltage, measured on pin F, 0-10V (0V = 0V, 10V = 100V)	
J		Vschweiss Reserved for special purposes	
K	Input	SYN_A Synchronisation for master/slave operation	
L	Input	Str/Stp Start / stop welding current, same as torch trigger. Only available in non-latched operating mode. +15V = start, 0V = stop	
M	Output	+15V Voltage supply +15V, max. 75mA	
N	Output	-15V Voltage supply -15V, max. 25mA	
P	-	NC Not assigned	
S	Output	0V Reference potential	
T	Output	list Actual welding current, measured on pin F; 0-10V (0V = 0A, 10V = 1000A)	
U		NC	
V	Output	SYN_A 0V Synchronisation for master/slave operation	

5.12 PC Interfaces

CAUTION



Equipment damage or faults may occur if the PC is connected incorrectly!
Not using the SECINT X10USB interface results in equipment damage or faults in signal transmission. The PC may be destroyed due to high frequency ignition pulses.

- Interface SECINT X10USB must be connected between the PC and the welding machine!
- The connection must only be made using the cables supplied (do not use any additional extension cables)!

NOTE



Please note the relevant documentation of the accessory components.

5.13 Machine configuration menu

The machine menu includes basic functions such as torch modes, display settings and the service menu.

5.13.1 Selecting, changing and saving parameters

NOTE



ENTER (enter the menu)

- Switch off machine at the main switch
- Press and hold the "welding parameters" button and switch the machine on again at the same time.

NAVIGATION (navigating in the menu)

- Parameters are selected by pressing the "welding parameters" button.
- Set or change the parameters by turning the "welding parameter setting" rotary dial.

EXIT (leave the menu)

- Select the "Elt" menu item.
- Press the "welding parameters" button (settings will be applied, machine changes to the ready-to-operate status).

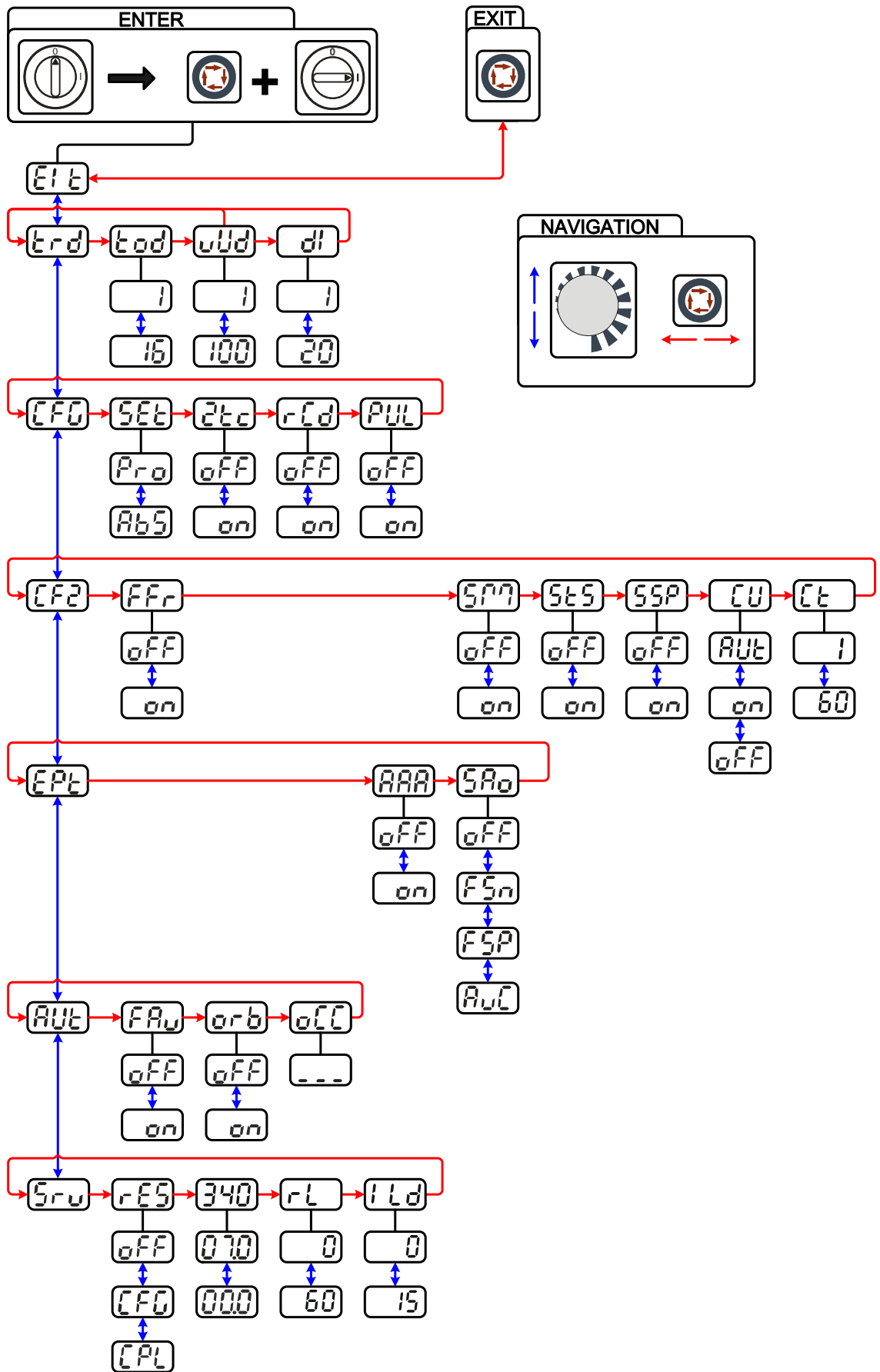







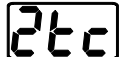



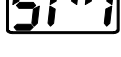
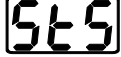





Figure 5-31

Display	Setting/selection
	Exit the menu Exit
	Torch configuration menu Set welding torch functions
	Torch mode (factory setting 1)
	Up-/Down speed Increase value = rapid current change (factory setting 10) Reduce value = slow current change
	Setting the first increment Setting: 1 to 20 (factory setting 1)
	Machine configuration Settings for machine functions and parameter display
	Welding current display (ignition, secondary, end and hotstart currents) <ul style="list-style-type: none"> • Pro = welding current display as a percentage of the main current (factory setting) • Abs = absolute welding current display
	Non-latched operation (C version) <ul style="list-style-type: none"> • on = on • off = off (factory setting)
	Power display switching (MMA) <ul style="list-style-type: none"> • on = actual value display • off = setpoint value display (factory setting)
	Pulses in the upslope and downslope phases The function can be switched on or off
	Machine configuration (part two) Settings for machine functions and parameter display
	Ramp function Remote control RTF 1 The ramp function can be switched on and off
	spotMatic Variation of operation mode spotArc, ignition with workpiece contact <ul style="list-style-type: none"> • on = on • off = off (factory setting)
	Setting spot time <ul style="list-style-type: none"> • on = Short spot time (5 ms - 999 ms, 1 ms- steps) • off = long spot time (0,01 s - 20,0 s, 10 ms- steps)
	Setting process activation <ul style="list-style-type: none"> • on = Separate process activation: The welding process has to be reactivated for every arc ignition by pressing the torch trigger. • off = Permanent process activation: The welding process is activated by pressing the torch trigger once. The following arc ignitions are initiated by shortly touching the tungsten electrode against the workpiece.
	Torch cooling mode <ul style="list-style-type: none"> • AUt = automatic operation (ex works) • on = permanently switched on • off = permanently switched off
	Water block pre-flow time Setting 1–60 min. (ex works 5)
	Expert menu

Display	Setting/selection
AAA	activArc voltage measuring <ul style="list-style-type: none"> • on = function on (factory setting) • off = function off
SA0	Error output to automated welding interface, contact SYN_A off AC synchronisation or hot wire (factory setting) FSn Error signal, negative logic FSP Error signal, positive logic AvC AVC (Arc voltage control) connection
AUT	Automation menu
FAU	Fast take-over of control voltage (automation) <ul style="list-style-type: none"> • on = function on • off = function off (factory setting)
orb	Orbital welding <ul style="list-style-type: none"> • off = off (ex works) • on = on
oCC	Orbital welding Correction value for orbital current
Srv	Service menu Modifications to the service menu may only be carried out by authorised maintenance staff!
rES	Reset (reset to factory settings) <ul style="list-style-type: none"> • off = aus (factory setting) • CFG = Reset the values in the machine configuration menu • CPL = Complete reset of all values and settings The reset is performed when leaving the menu (EXIT).
070	Software version query (example) 07= System bus ID
340	0340= Version number System bus ID and version number are separated by a dot.
rL	Only qualified service personnel may change the parameters!
lLd	Ignition pulse limit Setting 0 ms–15 ms (increments of 1 ms)

6 Maintenance, care and disposal

DANGER



Do not carry out any unauthorised repairs or modifications!

To avoid injury and equipment damage, the unit must only be repaired or modified by specialist, skilled persons!

The warranty becomes null and void in the event of unauthorised interference.

- Appoint only skilled persons for repair work (trained service personnel)!



Risk of injury from electric shock!

Cleaning machines that are not disconnected from the mains can lead to serious injuries!

- Disconnect the machine completely from the mains.
- Remove the mains plug!
- Wait for 4 minutes until the capacitors have discharged!

6.1 General

When used in the specified environmental conditions and under normal operating conditions, this machine is largely maintenance-free and requires a minimum of care.

There are some points, which should be observed, to guarantee fault-free operation of your welding machine. Among these are regular cleaning and checking as described below, depending on the pollution level of the environment and the length of time the unit is in use.

6.2 Maintenance work, intervals

Repair and maintenance work may only be performed by qualified authorised personnel; otherwise the right to claim under warranty is void. In all service matters, always consult the dealer who supplied the machine. Return deliveries of defective equipment subject to warranty may only be made through your dealer. When replacing parts, use only original spare parts. When ordering spare parts, please quote the machine type, serial number and item number of the machine, as well as the type designation and item number of the spare part.

6.2.1 Daily maintenance tasks

6.2.1.1 Visual inspection

- Mains supply lead and its strain relief
- Other, general condition

6.2.1.2 Functional test

- Operating, message, safety and adjustment devices (Functional test)
- Welding current cables (check that they are fitted correctly and secured)
- Gas tubes and their switching equipment (solenoid valve)
- Gas cylinder securing elements

6.2.2 Monthly maintenance tasks

6.2.2.1 Visual inspection



- Casing damage (front, rear and side walls)
- Wheels and their securing elements
- Transport elements (strap, lifting lugs, handle)

6.2.2.2 Functional test

- Selector switches, command devices, emergency stop devices, voltage reducing devices, message and control lamps

6.2.3 Annual test (inspection and testing during operation)

NOTE

-  The welding machine may only be tested by competent, capable persons.
A capable person is one who, because of his training, knowledge and experience, is able to recognise the dangers that can occur while testing welding power sources as well as possible subsequent damage and who is able to implement the required safety procedures.
-  For further information, please see the accompanying supplementary sheets "Machine and Company Data, Maintenance and Testing, Warranty"!

A periodic test according to IEC 60974-4 "Periodic inspection and test" has to be carried out. In addition to the regulations on testing given here, the relevant local laws and regulations must also be observed.

6.3 Disposing of equipment

NOTE

-  **Proper disposal!**
The machine contains valuable raw materials, which should be recycled, and electronic components, which must be disposed of.
 - Do not dispose of in household waste!
 - Observe the local regulations regarding disposal!



6.3.1 Manufacturer's declaration to the end user

- According to European provisions (guideline 2002/96/EG of the European Parliament and the Council of January, 27th 2003), used electric and electronic equipment may no longer be placed in unsorted municipal waste. It must be collected separately. The symbol depicting a waste container on wheels indicates that the equipment must be collected separately.
This machine is to be placed for disposal or recycling in the waste separation systems provided for this purpose.
- According to German law (law governing the distribution, taking back and environmentally correct disposal of electric and electronic equipment (ElektroG) from 16.03.2005), used machines are to be placed in a collection system separate from unsorted municipal waste. The public waste management utilities (communities) have created collection points at which used equipment from private households can be disposed of free of charge.
- Information about giving back used equipment or about collections can be obtained from the respective municipal administration office.
- EWM participates in an approved waste disposal and recycling system and is registered in the Used Electrical Equipment Register (EAR) under number WEEE DE 57686922.
- In addition to this, returns are also possible throughout Europe via EWM sales partners.

6.4 Meeting the requirements of RoHS

We, EWM AG Mündersbach, hereby confirm that all products supplied by us which are affected by the RoHS Directive, meet the requirements of the RoHS (Directive 2002/95/EC).

All products are subject to rigorous production checks and final checks. If, despite this, something fails to work at any time, please check the product using the following flowchart. If none of the fault rectification procedures described leads to the correct functioning of the product, please inform your authorised dealer.

6.5 Checklist for rectifying faults

NOTE



The correct machine equipment for the material and process gas in use is a fundamental requirement for perfect operation!

Legend	Symbol	Description
	↗	Fault/Cause
	✘	Remedy

Functional errors

- ↗ Insufficient coolant flow
 - ✘ Check coolant level and refill if necessary
 - ✘ Eliminate kinks in conduit system (hose packages)
 - ✘ Reset automatic cutout of the coolant pump by activating
- ↗ Air in the coolant circuit
 - ✘ see chapter "Vent coolant circuit"
- ↗ Machine control without displaying the signal lights after switching on
 - ✘ Phase failure > check mains connection (fuses)
- ↗ No welding performance
 - ✘ Phase failure > check mains connection (fuses)
- ↗ Various parameters cannot be set
 - ✘ Entry level is blocked, disable access lock (see chapter entitled "Lock welding parameters against unauthorised access")
- ↗ Connection problems
 - ✘ Make control lead connections and check that they are fitted correctly.

Welding torch overheated

- ↗ Loose welding current connections
 - ✘ Tighten power connections on the torch and/or on the workpiece
 - ✘ Tighten contact tip correctly
- ↗ Overload
 - ✘ Check and correct welding current setting
 - ✘ Use a more powerful welding torch

No arc ignition

- ✓ Incorrect ignition type setting.
 - ✗ Set ignition type changeover switch to the HF ignition setting.

Bad arc ignition

- ✓ Material inclusions in the tungsten electrode due to contact with filler material or workpiece
 - ✗ Regrind or replace the tungsten electrode
- ✓ Bad current transfer on ignition
 - ✗ Check the setting on the "Tungsten electrode diameter/Ignition optimisation" rotary dial and increase if necessary (higher ignition energy).

Unstable arc



- ✓ Material inclusions in the tungsten electrode due to contact with filler material or workpiece
 - ✗ Regrind or replace the tungsten electrode
- ✓ Incompatible parameter settings
 - ✗ Check settings and correct if necessary

Pore formation

- ✓ Inadequate or missing gas shielding
 - ✗ Check shielding gas setting and replace shielding gas cylinder if necessary
 - ✗ Shield welding site with protective screens (draughts affect the welding result)
 - ✗ Use gas lens for aluminium applications and high-alloy steels
- ✓ Unsuitable or worn welding torch equipment
 - ✗ Check size of gas nozzle and replace if necessary
- ✓ Condensation (hydrogen) in the gas tube
 - ✗ Purge hose package with gas or replace

6.6 Error messages (power source)

NOTE

-  A welding machine error is indicated by the collective fault signal lamp (A1) lighting up and an error code (see table) being displayed in the machine control display. In the event of a machine error, the power unit shuts down.
-  The display of possible error numbers depends on the machine version (interfaces/functions).

- If multiple errors occur, these are displayed in succession.
- Document machine errors and inform service staff as necessary.

Error message	Possible cause	Remedy
Err 3	Speedometer error	Check wire guide/hose package
	Wire feeder is not connected	<ul style="list-style-type: none"> • Switch off cold wire mode in the device configuration menu (off status) • Connect the wire feeder
Err 4	Temperature error	Allow the machine to cool down
	Error in emergency stop circuit (interface for automated welding)	<ul style="list-style-type: none"> • Check the external interrupt equipment • Check jumper JP 1 on PCB T320/1
Err 5	Overvoltage	Switch off machine and check the mains voltage
Err 6	Low voltage	
Err 7	Coolant error (with connected cooling unit only)	Check coolant level and refill if necessary
Err 8	Gas error	Check gas supply
Err 9	Secondary overvoltage	Switch machine off and on again, inform the service department if the error continues
Err 10	PE error	
Err 11	FastStop position	Edge 'Acknowledge error' signal (0 to 1) via robot interface (if available)
Err 12	VRD error	Switch the machine off and on again. If the error persists, inform the service dept.
Err 16	Pilot arc current	Check welding torch
Err 17	Cold wire error Excess current limit of a motor control card has been triggered Cold wire error – a permanent deviation between wire nominal value and actual value or a blocked drive has been detected in the process	Inspect the wire feed system (drives, tube packages, torch): <ul style="list-style-type: none"> • Check cold wire on the torch / work piece (moved against work piece?) • Check relation of process wire feed speed to robot travel speed, and correct if necessary • Check wire feed for stiffness with wire inching function (resolve by checking wire guides section by section) Reset error via robot interface (reset error)
Err 18	Plasma gas error Nominal value significantly different from actual value -> No plasma gas?	<ul style="list-style-type: none"> • Check plasma gas supply; use the plasma gas test function on "cold wire feed unit" if necessary • Check guiding / connections of the gas supply hose for leaks / kinks • Check that the gas supply lead of the plasma torch is not blocked Reset error via robot interface (reset error)
Err 19	Shielding gas Nominal value significantly different from actual value -> No shielding gas?	

Error message	Possible cause	Remedy
Err 20	Coolant The flow quantity of the torch coolant has fallen below the permissible minimum -> the coolant flow is dirty or cut off because the tube package has been unsuitably installed The flow quantity of the torch coolant has fallen below the permissible level	Check coolant level and refill if necessary <ul style="list-style-type: none"> • Check coolant level in the reverse cooler • Check coolant lines for leaks and kinks • Check that the coolant inlet and outlet on the plasma torch is not blocked Reset error via robot interface (reset error)
Err 22	Excess temperature in coolant circuit Coolant temperature exceeded The temperature of the coolant is too high	<ul style="list-style-type: none"> • Check coolant level in the reverse cooler • Check temperature nominal value on the cooling unit Reset error via robot interface (reset error)
Err 23	HF choke excess temperature High frequency blocking inductor excess temperature The excess temperature of the high frequency blocking inductor has triggered	<ul style="list-style-type: none"> • Allow equipment to cool down • Adjust processing cycle times if necessary Reset error via robot interface (reset error)
Err 24	Pilot arc ignition error	Check plasma torch replacement parts
Err 32	Electronics error (I>0 error)	Switch the machine off and on again. If the error persists, inform the service dept.
Err 33	Electronics error (Uactual error)	
Err 34	Electronics error (A/D channel error)	
Err 35	Electronics error (edge error)	
Err 36	Electronics error (S sign)	
Err 37	Electronics error (temperature error)	Allow machine to cool down.
Err 38	---	Switch the machine off and on again. If the error persists, inform the service dept.
Err 39	Electronics error (secondary overvoltage)	
Err 48	Ignition error	Check welding process
Err 49	Arc interruption	Inform the Service department
Err 51	Error in emergency stop circuit (interface for automated welding)	<ul style="list-style-type: none"> • Check the external interrupt equipment • Check jumper JP 1 on PCB T320/1

6.7 Resetting welding parameters to the factory settings

NOTE

All customised welding parameters that are stored will be replaced by the factory settings.

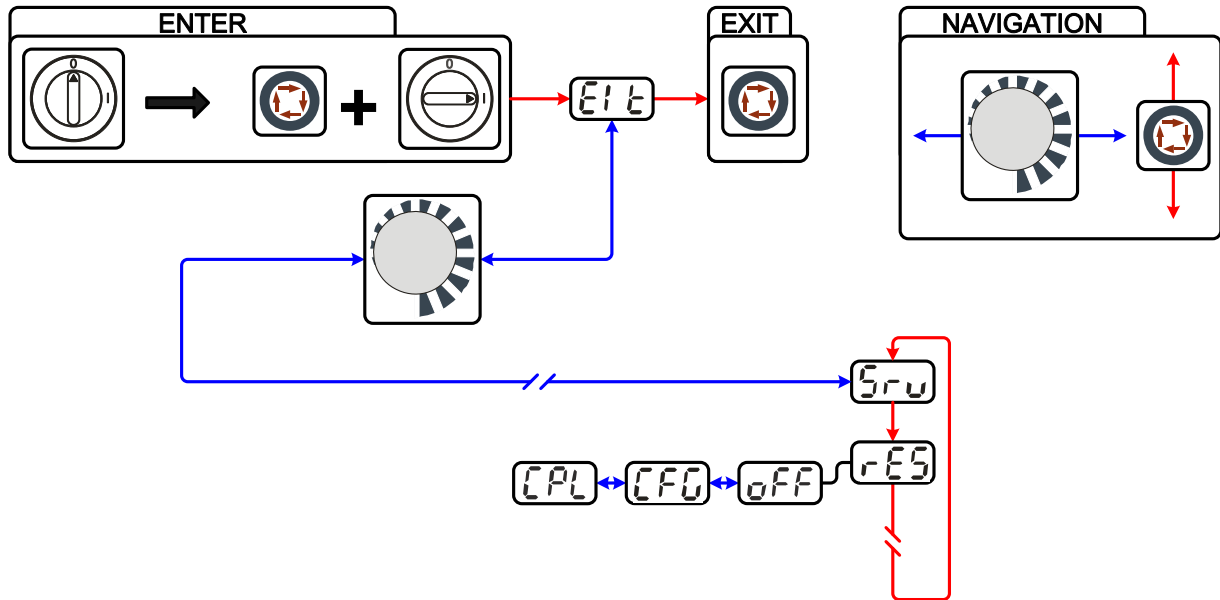

Figure 6-1

Display	Setting/selection
	Exit the menu Exit
	Service menu Modifications to the service menu may only be carried out by authorised maintenance staff!
	Reset (reset to factory settings) <ul style="list-style-type: none"> • off = aus (factory setting) • CFG = Reset the values in the machine configuration menu • CPL = Complete reset of all values and settings The reset is performed when leaving the menu (EXIT).
	Switch off Switching off machine function
	Reset machine configuration Resetting the values in the machine configuration menu
	Complete reset Complete reset of all values and settings by the factory settings

6.8 Display machine control software version

NOTE

The query of the software versions only serves to inform the authorised service staff!

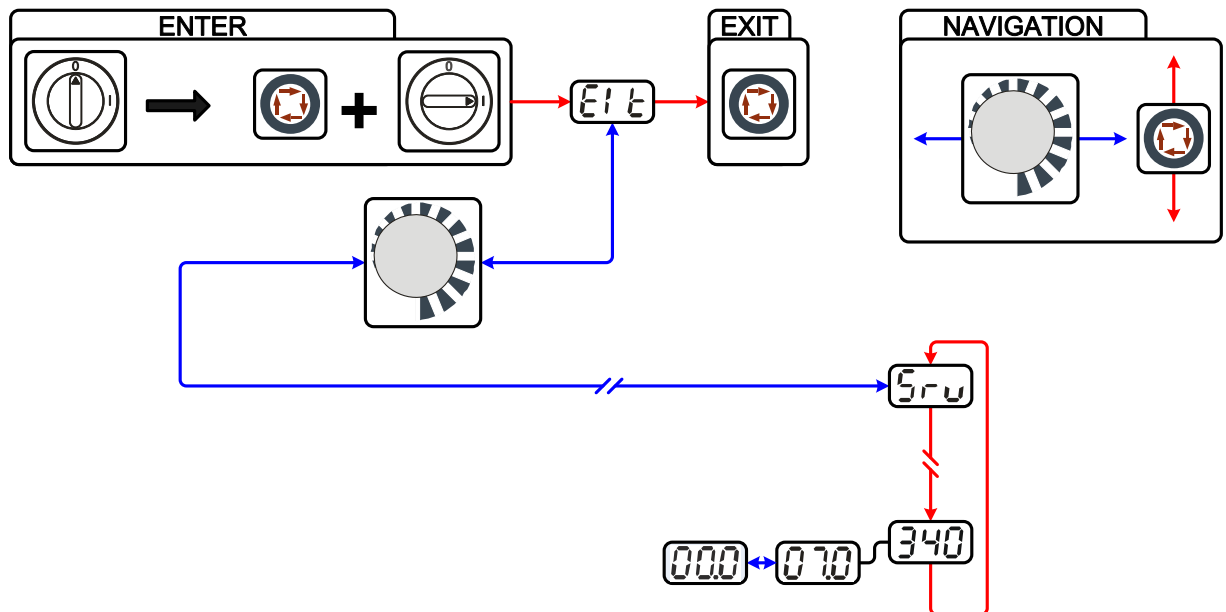

Figure 6-2

Display	Setting/selection
	Exit the menu Exit
	Service menu Modifications to the service menu may only be carried out by authorised maintenance staff!
	Software version query (example) 07= System bus ID
	0340= Version number System bus ID and version number are separated by a dot.

6.9 General operating problems

6.9.1 Interface for automated welding

WARNING



No function of the external interrupt equipment (emergency stop switch)!

If the emergency stop circuit has been realised using an external interrupt equipment via the interface for automated welding, the machine must be configured for this setup. If this is not observed, the power source will ignore the external interrupt equipment and will not shut down!

- Disconnect jumper 1 on PCB T320/1 (Tetrix / forceTig) or M320/1 (Phoenix / alpha Q)!

6.10 Vent coolant circuit

NOTE

 To vent the cooling system always use the blue coolant connection, which is located as deep as possible inside the system (close to the coolant tank)!

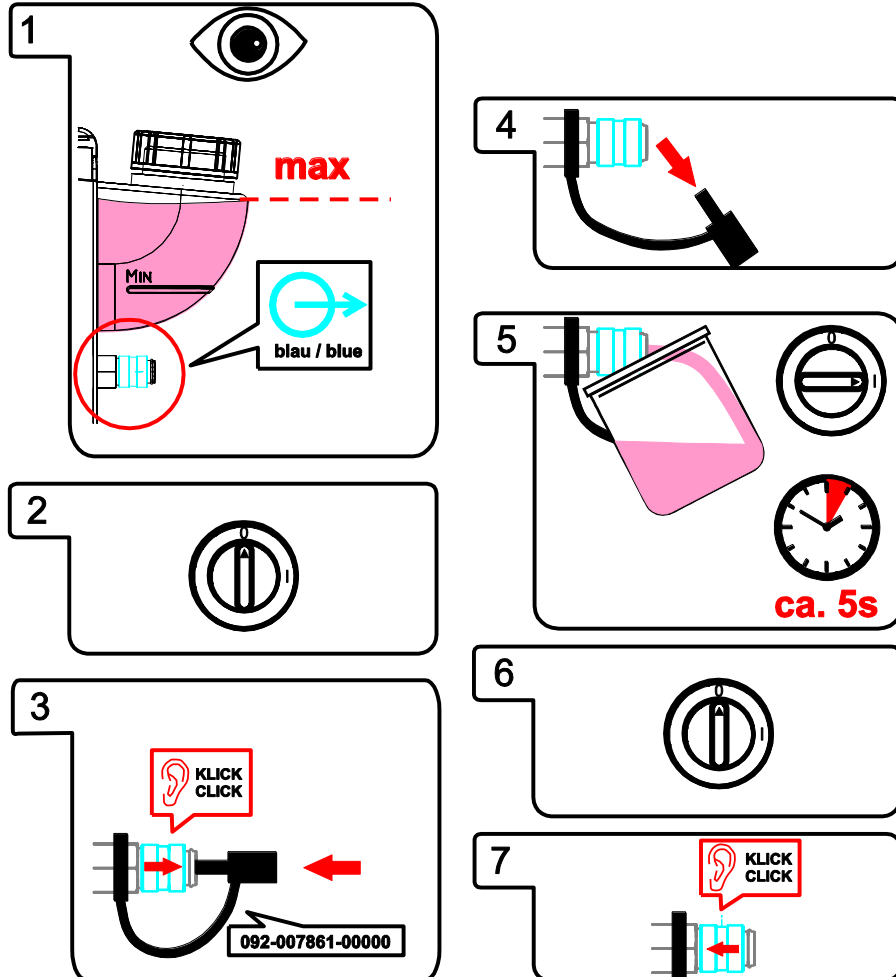



Figure 6-3

7 Technical data

NOTE

 Performance specifications and guarantee only in connection with original spare and replacement parts!

7.1 Tetrix 351 FW

	TIG	MMA
Welding current	5 A to 350 A	
Welding voltage	10.2 V to 24.0 V	20.2 V to 34.0 V
Duty cycle at 40 °C		
100% DC	350 A	
Load alternation	10 min. (60% DC \triangle 6 min. welding, 4 min. pause)	
Open circuit voltage	79 V	
Mains voltage (tolerances)	3 x 400 V (-25% to +20%)	
Frequency	50/60 Hz	
Mains fuse (safety fuse, slow-blow)	3 x 25 A	
Mains connection lead	H07RN-F4G6	
Max. connected load	10.9 kVA	15.4 kVA
Recommended generator rating	20.8 kVA	
cos ϕ	0.99	
Insulation class/protection classification	H/IP 23	
Ambient temperature*	-25 °C to +40 °C	
Machine/torch cooling	Fan/gas or water	
Cooling capacity at 1 l/min	1500 W	
Max. flow rate	5 l/min	
Coolant outlet pressure	max. 3.5 bar	
Max. tank capacity	12 l	
Workpiece lead	70 mm ²	
Dimensions L/W/H	1100 x 455 x 1000 mm	
Weight	126 kg	
EMC class	A	
Constructed to standard	IEC 60974-1, -2, -3, -10  / 	

NOTE

* Ambient temperature depends on coolant!
Observe the coolant temperature range for the welding torch cooling!



7.2 Tetrix 401 FW

	TIG	MMA
Welding current	5 A to 400 A	
Welding voltage	10.2 V to 26.0 V	20.2 V to 36.0 V
Duty cycle at 40 °C		
100% DC	400 A	
Load alternation	10 min. (60% DC \triangle 6 min. welding, 4 min. pause)	
Open circuit voltage	79 V	
Mains voltage (tolerances)	3 x 400 V (-25% to +20%)	
Frequency	50/60 Hz	
Mains fuse (safety fuse, slow-blow)	3 x 32 A	
Mains connection lead	H07RN-F4G6	
Max. connected load	13,5 kVA	18,2 kVA
Recommended generator rating	25.0 kVA	
cos ϕ	0.99	
Insulation class/protection classification	H/IP 23	
Ambient temperature *	-25 °C to +40 °C	
Machine/torch cooling	Fan/gas or water	
Cooling capacity at 1 l/min	1500 W	
Max. flow rate	5 l/min	
Coolant outlet pressure	max. 3.5 bar	
Max. tank capacity	12 l	
Workpiece lead	70 mm ²	
Dimensions L/W/H	1100 x 455 x 1000 mm	
Weight	126 kg	
EMC class	A	
Constructed to standards	IEC 60974-1, -2, -3, -10 	

NOTE

- * Ambient temperature depends on coolant!
Observe the coolant temperature range for the welding torch cooling!

7.3 Tetrrix 451 FW

	TIG	MMA
Welding current	5 A to 450 A	
Welding voltage	10.2 V to 28.0 V	20.2 V to 38.0 V
Duty cycle at 40 °C		
80% DC	450 A	
100% DC	420 A	
Load alternation	10 min. (60% DC \triangle 6 min. welding, 4 min. pause)	
Open circuit voltage	79 V	
Mains voltage (tolerances)	3 x 400 V (-25% to +20%)	
Frequency	50/60 Hz	
Mains fuse (safety fuse, slow-blow)	3 x 32 A	
Mains connection lead	H07RN-F4G6	
Max. connected load	15,9 kVA	22,0 kVA
Recommended generator rating	29,1 kVA	
cos ϕ	0.99	
Insulation class/protection classification	H/IP 23	
Ambient temperature*	-25 °C to +40 °C	
Machine/torch cooling	Fan/gas or water	
Cooling capacity at 1 l/min	1500 W	
Max. flow rate	5 l/min	
Coolant outlet pressure	max. 3.5 bar	
Max. tank capacity	12 l	
Workpiece lead	70 mm ²	
Dimensions L/W/H	1100 x 455 x 1000 mm	
Weight	131 kg	
EMC class	A	
Constructed to standard	IEC 60974-1, -2, -3, -10  / 	

NOTE

- * Ambient temperature depends on coolant!
 Observe the coolant temperature range for the welding torch cooling!

7.4 Tetrix 551 FW

	TIG	MMA
Welding current	5 A to 550 A	
Welding voltage	10.2 V to 32.0 V	20.2 V to 42.0 V
Duty cycle at 40 °C		
60% DC	550 A	
100% DC	420 A	
Load alternation	10 min. (60% DC \triangleq 6 min. welding, 4 min. pause)	
Open circuit voltage	79 V	
Mains voltage (tolerances)	3 x 400 V (-25% to +20%)	
Frequency	50/60 Hz	
Mains fuse (safety fuse, slow-blow)	3 x 35 A	
Mains connection lead	H07RN-F4G6	
Max. connected load	22.6 kVA	29.5 kVA
Recommended generator rating	39.8 kVA	
cos ϕ	0.99	
Insulation class/protection classification	H/IP 23	
Ambient temperature*	-25 °C to +40 °C	
Machine/torch cooling	Fan/gas or water	
Cooling capacity at 1 l/min	1500 W	
Max. flow rate	5 l/min	
Coolant outlet pressure	max. 3.5 bar	
Max. tank capacity	12 l	
Workpiece lead	95 mm ²	
Dimensions L/W/H	1100 x 455 x 1000 mm	
Weight	131 kg	
EMC class	A	
Constructed to standard	IEC 60974-1, -2, -3, -10 ☒ / CE	

NOTE

- * Ambient temperature depends on coolant!
Observe the coolant temperature range for the welding torch cooling!

8 Accessories

NOTE



Performance-dependent accessories like torches, workpiece leads, electrode holders or intermediate hose packages are available from your authorised dealer.

8.1 Remote controls and accessories

Type	Designation	Item no.
RTF1 19POLE 5M	Foot-operated remote control current with connection cable	094-006680-00000
RTF2 19POL 5 m	Foot-operated remote control current with connection cable	090-008764-00000
RT1 19POL	Remote control current	090-008097-00000
RTG1 19POL	Remote control, current	090-008106-00000
RTP1 19POL	Remote control spot welding / pulses	090-008098-00000
RTP2 19POL	Remote control spot welding / pulses	090-008099-00000
RTP3 spotArc 19POL	spotArc remote control for spot welding / pulses	090-008211-00000
RA5 19POL 5M	Remote control e.g. connection cable	092-001470-00005
RA10 19POL 10M	Remote control e.g. connection cable	092-001470-00010
RA20 19POL 20M	Remote control e.g. connection cable	092-001470-00020
RV5M19 19POLE 5M	Extension cable	092-000857-00000

8.2 Options

Type	Designation	Item no.
ON 7pol	Optional 7-pole retrofit connection socket Accessory components and digital interfaces	092-001826-00000
ON 19pol 351/451/551	Optional 19-pole retrofit connection socket Accessory components and analogue A interface	092-001951-00000
ON Filter T/P	Retrofit option contamination filter for air inlet	092-002092-00000
ON Hose/FR Mount	Optional holder for tubes and remote control for machines without pivot support	092-002116-00000
ON LB Wheels 160x40MM	Retrofit option for locking brake for machine wheels	092-002110-00000
ON Tool Box	Retrofit option tool box	092-002138-00000
ON Holder Gas Bottle <50L	Holding plate for gas cylinders smaller than 50 litres	092-002151-00000
ON Shock Protect	Ram protection retrofit option	092-002154-00000

8.3 General accessories

Type	Designation	Item no.
KF 23E-10	Coolant (-10 °C), 9.3 l	094-000530-00000
KF 23E-200	Coolant (-10 °C), 200 litres	094-000530-00001
KF 37E-10	Coolant (-20 °C), 9.3 l	094-006256-00000
KF 37E-200	Coolant (-20 °C), 200 l	094-006256-00001
TYP 1	Frost protection tester	094-014499-00000
DMDIN TN 200B AR/MIX 35L	Manometer pressure regulator	094-000009-00000
GH 2X1/4" 2M	Gas hose	094-000010-00001
HOSE BRIDGE UNI	Tube bridge	092-007843-00000
5POLE/CEE/32A/M	Machine plug	094-000207-00000
ADAP 8-5 POL	8 to 5-pole adapter	092-000940-00000

8.4 Computer communication

Type	Designation	Item no.
PC300.Net	PC300.Net welding parameter software kit incl. cable and SECINT X10 USB interface	090-008777-00000

9 Appendix A

9.1 Overview of EWM branches

Headquarters

EWM AG
Dr. Günter-Henle-Straße 8
56271 Mündersbach · Germany
Tel: +49 2680 181-0 · Fax: -244
www.ewm-group.com · info@ewm-group.com

Technology centre

EWM AG
Forststraße 7-13
56271 Mündersbach · Germany
Tel: +49 2680 181-0 · Fax: -144
www.ewm-group.com · info@ewm-group.com



Production, Sales and Service

EWM AG
Dr. Günter-Henle-Straße 8
56271 Mündersbach · Germany
Tel: +49 2680 181-0 · Fax: -244
www.ewm-group.com · info@ewm-group.com

EWM HIGHTEC WELDING (Kunshan) Ltd.
10 Yuanshan Road, Kunshan · New & High-tech Industry Development Zone
Kunshan · Jiangsu · 215300 · People's Republic of China
Tel: +86 512 57867-188 · Fax: -182
www.ewm-kunshan.cn · info@ewm-kunshan.cn

EWM HIGHTEC WELDING AUTOMATION GmbH
Boxbachweg 4
08606 Oelsnitz/V. · Germany
Tel: +49 37421 20-300 · Fax: -318
www.ewm-automation.de · info@ewm-automation.de

TEAMWELDER s.r.o.
Tř. 9. května 718 / 31
407 53 Jířkov · Czech Republic
Tel.: +420 412 358-551 · Fax: -504
www.teamwelder.cz · info@teamwelder.cz

Sales and Service Germany

EWM AG
Sales and Technology Centre
Grünauer Fenn 4
14712 Rathenow · Tel: +49 3385 49402-0 · Fax: -20
www.ewm-rathenow.de · info@ewm-rathenow.de

EWM HIGHTEC WELDING GmbH
Rudolf-Winkel-Str. 7-9
37079 Göttingen · Tel: +49 2623 9276-0 · Fax: -244
www.ewm-goettingen.de · info@ewm-goettingen.de

EWM HIGHTEC WELDING GmbH
Sachsstraße 28
50259 Pulheim · Tel: +49 2234 697-047 · Fax: -048
www.ewm-pulheim.de · info@ewm-pulheim.de

EWM HIGHTEC WELDING GmbH
Sales and Logistics Centre
Sälzerstraße 20a
56235 Ransbach-Baumbach · Tel: +49 2623 9276-0 · Fax: -244
www.ewm-ransbach-baumbach.de · info@ewm-ransbach-baumbach.de

EWM HIGHTEC WELDING GmbH
Eiserfelder Straße 300
57080 Siegen · Tel: +49 271 3878103-0 · Fax: -9
www.ewm-siegen.de · info@ewm-siegen.de

EWM HIGHTEC WELDING GmbH
Sales and Technology Centre
Draisstraße 2a
69469 Weinheim · Tel: +49 6201 84557-0 · Fax: -20
www.ewm-weinheim.de · info@ewm-weinheim.de

EWM Schweißtechnik Handels GmbH
Bildstock 9/3-4
88085 Langenargen · Tel: +49 7543 9344-30 · Fax: -50
www.ewm-langenargen.de · info@ewm-langenargen.de

EWM Schweißtechnik Handels GmbH
Pffaffensteig 17
89143 Blaubeuren · Tel: +49 7344 9191-75 · Fax: -77
www.ewm-blaubeuren.de · info@ewm-blaubeuren.de

EWM Schweißtechnik Handels GmbH
Heinkelstraße 8
89231 Neu-Ulm · Tel: +49 731 7047939-0 · Fax: -15
www.ewm-neu-ulm.de · info@ewm-neu-ulm.de

EWM HIGHTEC WELDING AUTOMATION GmbH
Steinfeldstraße 15
90425 Nürnberg · Tel: +49 911 3841-727 · Fax: -728
www.ewm-automation.de · info@ewm-automation.de

Sales and Service International

EWM HIGHTEC WELDING GmbH
Wiesenstraße 27b
4812 Pinsdorf · Austria · Tel: +43 7612 778 02-0 · Fax: -20
www.ewm-austria.at · info@ewm-austria.at

EWM HIGHTEC WELDING (Kunshan) Ltd.
10 Yuanshan Road, Kunshan · New & High-tech Industry Development Zone
Kunshan · Jiangsu · 215300 · People's Republic of China
Tel: +86 512 57867-188 · Fax: -182
www.ewm-kunshan.cn · info@ewm-kunshan.cn

EWM HIGHTEC WELDING UK Ltd.
Unit 2B Coopies Way · Coopies Lane Industrial Estate
Morpeth · Northumberland · NE61 6JN · Great Britain
Tel: +44 1670 505875 · Fax: -514305
www.ewm-morpeth.co.uk · info@ewm-morpeth.co.uk

EWM HIGHTEC WELDING Sales s.r.o. / Prodejní a poradenské centrum
Tyršova 2106
256 01 Benešov u Prahy · Czech Republic
Tel: +420 317 729-517 · Fax: -712
www.ewm-benesov.cz · info@ewm-benesov.cz

