

OPERATING INSTRUCTIONS AND PARTS MANUAL

# MODEL F18/50C

Nailer / Staper

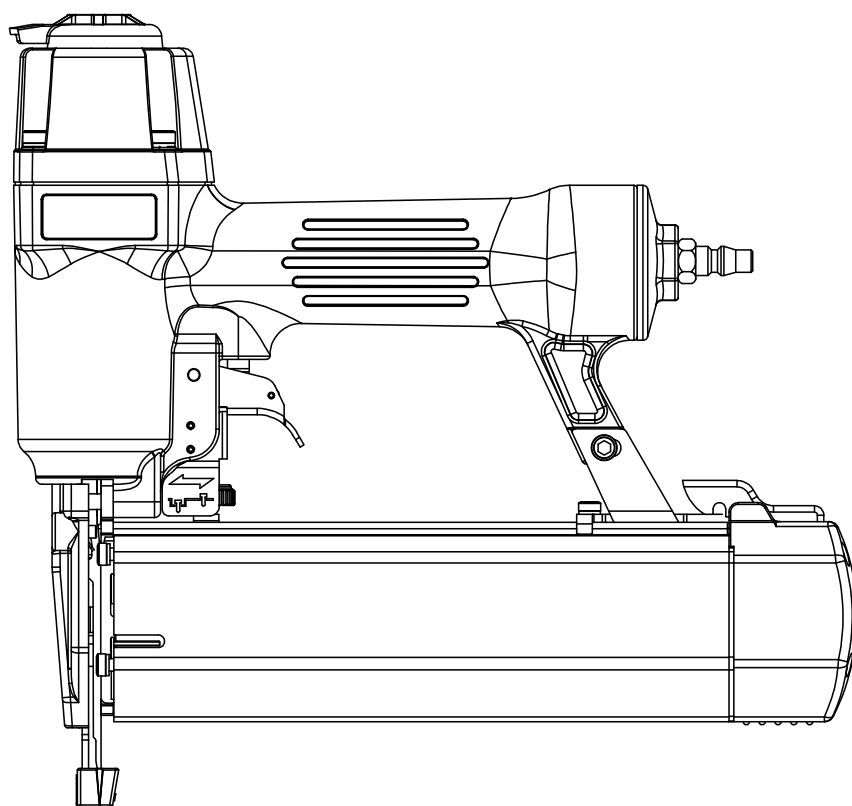

CAREFULLY READ THIS MANUAL BEFORE OPERATING TOOL

**APLUS Pneumatic Corp.**  
NO.579, SEC. 1, SHEN LIN RD., TAYA, TAICHUNG CITY 428 TAIWAN, R.O.C.  
Tel: 886-4-25602860 Fax: 886-4-25602859  
Original instructions

OPERATING INSTRUCTIONS AND PARTS MANUAL

# MODEL F18/50C

Nailer / Stapler

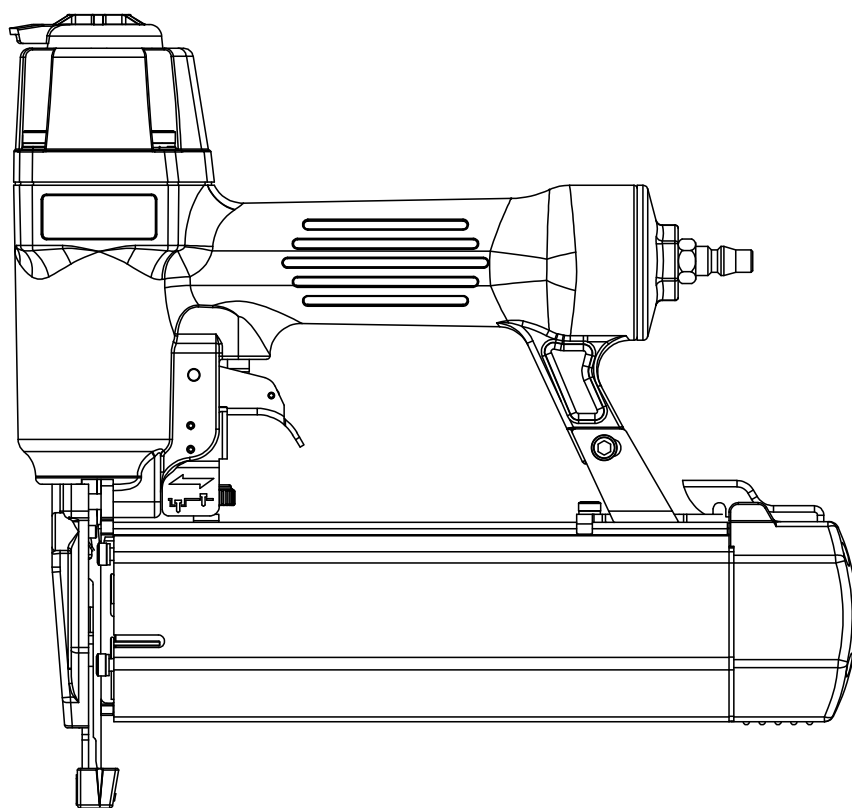

CAREFULLY READ THIS MANUAL BEFORE OPERATING TOOL

## TOOL SPECIFICATIONS

MODEL OF TOOL .....	F18/50C
TOOL LENGTH .....	10.62" (270 mm)
TOOL HEIGHT .....	9.84" (250 mm)
TOOL WIDTH .....	2.32" (59 mm)
WEIGHT (WITHOUT FASTENERS) .....	3.31 lbs (1.5 kg)
AIR INLET .....	1/4" NPT
<b>COMPRESSED AIR :</b>	
Maximum permissible operating pressure .....	110 PSIG (7.5 bar)
Recommended operating pressure range .....	60 ~ 100 PSIG (4 ~ 7 bar)
AIR CONSUMPTION .....	0.0172 scfm with 25 nails per minute @ 100 psi (6.9 bar)

<b>Noise dB(A) :</b>	
A-weighted sound pressure level LpA.....	86.02 dB(A)
A-weighted sound power level LwA.....	99.02 dB(A)
Measurement uncertainty: 3dB	
<b>Vibration (m/s<sup>2</sup>) :</b>	
Hand-arm vibration value.....	3.38 m/s <sup>2</sup>
Measurement uncertainty: 1.5 m/s <sup>2</sup>	

**Warning:**  
The vibration emission during actual use of the power tool can differ from the declared total value depending on the ways in which the tool is used; and of the need to identify safety measures to protect the operator that are based on an estimation of exposure in the actual conditions of use (taking account of all parts of the operation cycle such as the times when the tool is switched off and when it is running idle in addition to the trigger time).

List of fasteners for F18/50C :

Nail	Crown	Thickness	Width	MAGAZINE
Brad	2.0 mm , 0.08 "	1.0 mm , 0.04 "	1.25 mm , 0.05 "	100 pcs
Stapler	5.8 mm , 0.23 "	1.0 mm , 0.04 "	1.25 mm , 0.05 "	

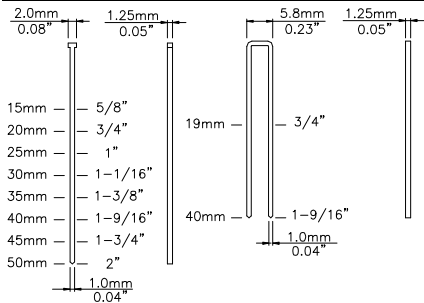

**Foreword:**  
This pneumatic stapler is designed for moulding, hobbies and most other jobs requiring a hammer. Its well balanced, ergonomic, comfort non-slip cushioned grip and heavy duty driving compatible staples to proper applications. Features long protruding nose to nail/staple into tight corners/groves, easy loading magazine are exactly what master needed. No more painful hammering and ensure you as

satisfactory tackle and enjoy work.

### Suitable applications:

Wood and wood like applications, MDF, Hobby/Craft, fine decorative trim, beading and moulding. Tongue & Groove paneling. Cabinet and plywood assembly, garden furniture and trellis work, door/window assembly, hardwood flooring, paneling and trim. Picture/mirror frames. Sub-flooring and many more.... This electric tool is restricted to using on wood, wood like products, leather and material of paper. Any other material is forbidden.

### Caution:

Not suitable for stapling or nailing into concrete, masonry bricks or steel. Do not fire if nails are jammed, as this will cause damage to the driver blade.



Indicates an imminently hazardous situation which, if not avoided, will result in death or serious injury.



Indicates a potentially hazardous situation which, if not avoided, will result in death or serious injury.



Alerts the operator to useful information.

## SAFETY INSTRUCTIONS



1. Read this manual and understand all safety instructions before operation the tool. If you have any questions, please contact our authorized representatives.
2. Only those fasteners listed in the operating instructions may be used in the fastener driving tools.
3. Only the main energy and the lubricants listed in the operating instructions may be used.
4. Fastener driving tools marked with an inverted equilateral triangle standing on one point may only be used with an effective safety yoke.
5. Fastener driving tools equipped with contact actuation or continuous contact actuation, marked with the symbol " Do not use on scaffoldings, ladders", shall not be used for specific application for example:
  - when changing one driving location to another involves the use of scaffoldings, stairs, ladders, or ladder alike constructions, e.g. roof laths,
  - closing boxes or crates,

—fitting transportation safety systems e.g. on vehicles and wagons.

6. For the maintenance of fastener driving tools, only spare parts specified by the manufacturer or his authorized representative shall be used.
7. Repairs shall carried out by agents authorized by the manufacturer or by other specialists, having due regard to the information given in the operating instruction.
8. Stands for mounting the fastener driving tools to a support for example a work table shall be designed and constructed by the stand manufacturer in such a way that the fastener driving tool can be safely fixed for the intended use, thus for example avoiding damage, distortion or displacement.
9. Fastener driving tools operated by compressed air shall only be connected to compressed air lines where the maximum allowable pressure cannot be exceed by a factor of more than 10%, which can for example be achieved by a pressure reduction valve which includes a downstream safety valve.
10. When using fastener driving tools operated by compressed air, particular attention must be paid to avoid exceeding the maximum allowable pressure.
11. When using fastener driving tools operated by compressed air should only be operated at the lowest pressure required for the work process at hand, in order to prevent unnecessarily high noise levels, increased wear and resulting failures.
12. Hazards caused by fire and explosion when using oxygen or combustible gases for operating compressed air operated fastener driving tools.
13. Carry the fastener driving tool at workpiece using only the handgrip, and never with the trigger actuated. Never carry the tool by the hose or pull the hose to move the tool.

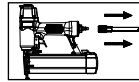

14. Disconnect the tool from air supply before cleaning jams, servicing, adjusting, and during non-operation.



15. Wear eye protection.

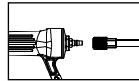

16. Do not use a check valve or any other fitting which allows air to remain in the tool.



17. Do not place your hand or any part of your body in the fastener discharge area of the tool when connecting or disconnecting air supply.



18. Never point tool at yourself or at any other person.



19. Do not use on scaffoldings, ladders.

## AIR SUPPLY AND CONNECTION



- Many air tool users find it convenient to use oiler to help provide oil circulation through tool and increase the efficiency and useful life of the tool. Check oil level in the oiler daily.
- Many air tool user find it convenient to use a filter to remove liquid and impurities which can rust or wear internal parts of the tool. A filter also increase the efficiency and useful of the tool. The filter must be checked on a daily basis and if necessary drained.
- For better performance, install a 3/8" quick connector (1/4" NPT threads) with an inside diameter of .315" on your tool and a 3/8" quick coupler on the air hose.

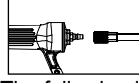
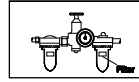
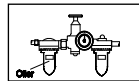

The following illustration shows the correct mode of connection to the air supply system which will increase the efficiency and useful life of the tool.

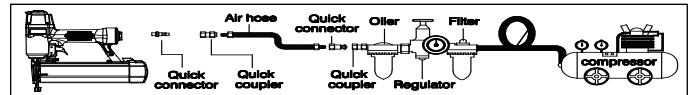

## LUBRICATION AND MAINTENANCE

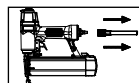

- Disconnect the air supply from the tool before lubricating.

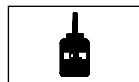

- Your tool requires lubrication before you use it for the first time.

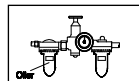

- Wipe off excessive oil at the exhaust. Excessive oil will damage O-rings of tool. If in-line oiler is used, manual lubrication through the air inlet is not required on a daily basis.



- Turn the tool so the inlet is facing up and put one drop of high speed spindle oil, UNOCAL RX22, or 3-IN-1 oil into air inlet. Never use detergent oil or additives. Operate the tool briefly after adding oil.

## LOADING THE TOOL

### **WARNING**

- Do not place your hand or any part of your body in the fastener discharge area of the tool when connecting or disconnecting air supply.

### **WARNING**

- Never point any operational fastener driving tool at yourself or at any other person.

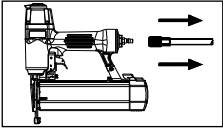

1. Disconnect air hose.

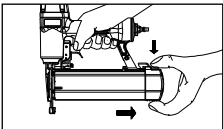

2. Depress the magazine latch. Pull back on the magazine cover.

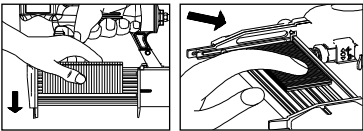

3. Insert a stick of fasteners into the magazine. Make sure the pointed ends of the fasteners are loaded with the points downward. Also make sure fasteners are not dirty or damaged.

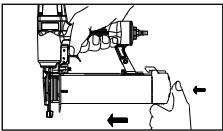

4. Push the magazine cover forward until the latch catches.

## OPERATING THE TOOL

### **WARNING**

Protect your eyes and ears. Wear z87.1 safety glasses with side shields. Wear hearing protection. Employers and users are responsible for ensuring the user or anyone near the tool wear this safety protection.



### **NOTE**

Check and replace any damaged or worn components on the tool. The safety warning labels on the tool must also be replaced if they are not legible.

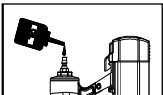

Fig.1

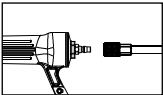

Fig.2

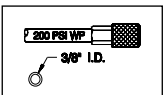

Fig.3

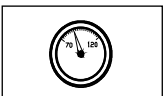

Fig.4

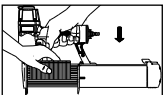

Fig.5

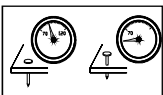

Fig.6

1. Add a few drops of UNOCAL RX22 or 3-in-1 oil into the air inlet. (See Fig. 1)

2. Attach a high flow quick connect fitting to the tool. (See Fig. 2)

3. Empty the magazine.

4. Connect the tool to an air compressor using a 3/8" I.D hose. Make sure the hose has a rated working pressure exceeding 200 PSI (13.8bar) and a female quick coupler. (See Fig. 3)

5. Regulate the air pressure to obtain 70 PSI (4.8 bar) at the tool. (See Fig. 4)

6. Disconnect the air supply from the tool.

7. Load fasteners into your tool following the instructions in this manual. (See Fig. 5)

8. Reconnect the air supply to the tool.

9. Test for proper fastener penetration by driving nails into a sample piece of wood. If the fasteners do not achieve the desired penetration, adjust the air pressure to a higher setting until the desired penetration is achieved. Do not exceed 110 PSI (7.6 bar) at the tool. (See Fig. 6)

## CONTACT SAFETY TRIP MECHANISM

OPERATING A CONTACT SAFETY TRIP TOOL :

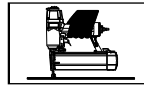

- The operator requires finger to be off the trigger and the nose of the tool to be placed on the workpiece.

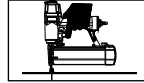

- The contact safety trip mechanism is then depressed against the workpiece and the trigger is pulled to drive a fastener.

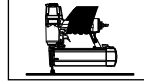

- The trigger is released after each fastener is driven.

- Move the tool to next location and the above procedure repeated.

CHECKING OPERATION OF CONTACT SAFETY TRIP MECHANISM:

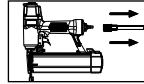

- Disconnect the air supply from the tool.

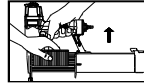

- Empty the magazine.

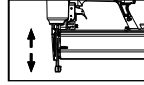

- Make sure the trigger and contact safety trip mechanism move up and down without any sticking.

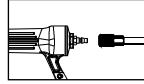

- Connect air supply to the tool.

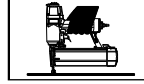

- Depress the contact safety trip mechanism against the workpiece without pulling the trigger. The tool must not cycle. Never use the tool if a cycle occurs.

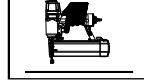

- Hold the tool clear of the workpiece. The contact safety trip mechanism should return to its original down position. Pull the trigger. The tool must not cycle. Never use the tool if a cycle occurs.

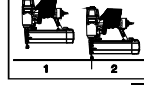

- Depress the contact safety mechanism again the workpiece and pull the trigger, the tool must cycle.

## CLEARING A JAM FROM THE TOOL

### **WARNING**

Disconnect the tool from air compressor before adjusting, clearing jams, servicing, relocating and during non-operation.

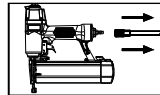

1. Fastener jammed in fastener discharge area:

- Disconnect tool from air hose.
- Grab jammed fastener with pliers and remove.

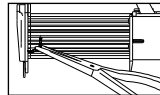

2. Fastener jam inside magazine:

- Disconnect air tool from air hose.
- Pull back on fastener pusher until locked.
- Removed jammed fastener.
- Release fastener pusher.

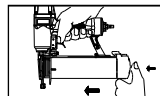

## CLEANING THE TOOL

### **DANGER**

Never use gasoline or other flammable liquids to clean the tool. Vapors in the tool will ignite by a spark and cause the tool to explode and result in death or serious personal injury.



### **NOTE**

Solvents used to clean the nose of the tool and contact safety trip mechanism may soften the tar on the shingles and cause the buildup to be accelerated. Make sure to dry the tool thoroughly after cleaning and before operating the tool again.

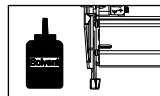

1. Disconnect the air supply from the tool.

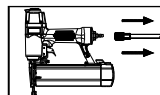

2. Remove tar buildup with kerosene #2 fuel oil or diesel fuel. Do not allow solvent to get into the cylinder or damage may occur. Dry off the tool completely before use.

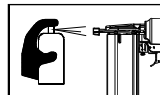

# F18/50CC05 (FK/S2-05)

a

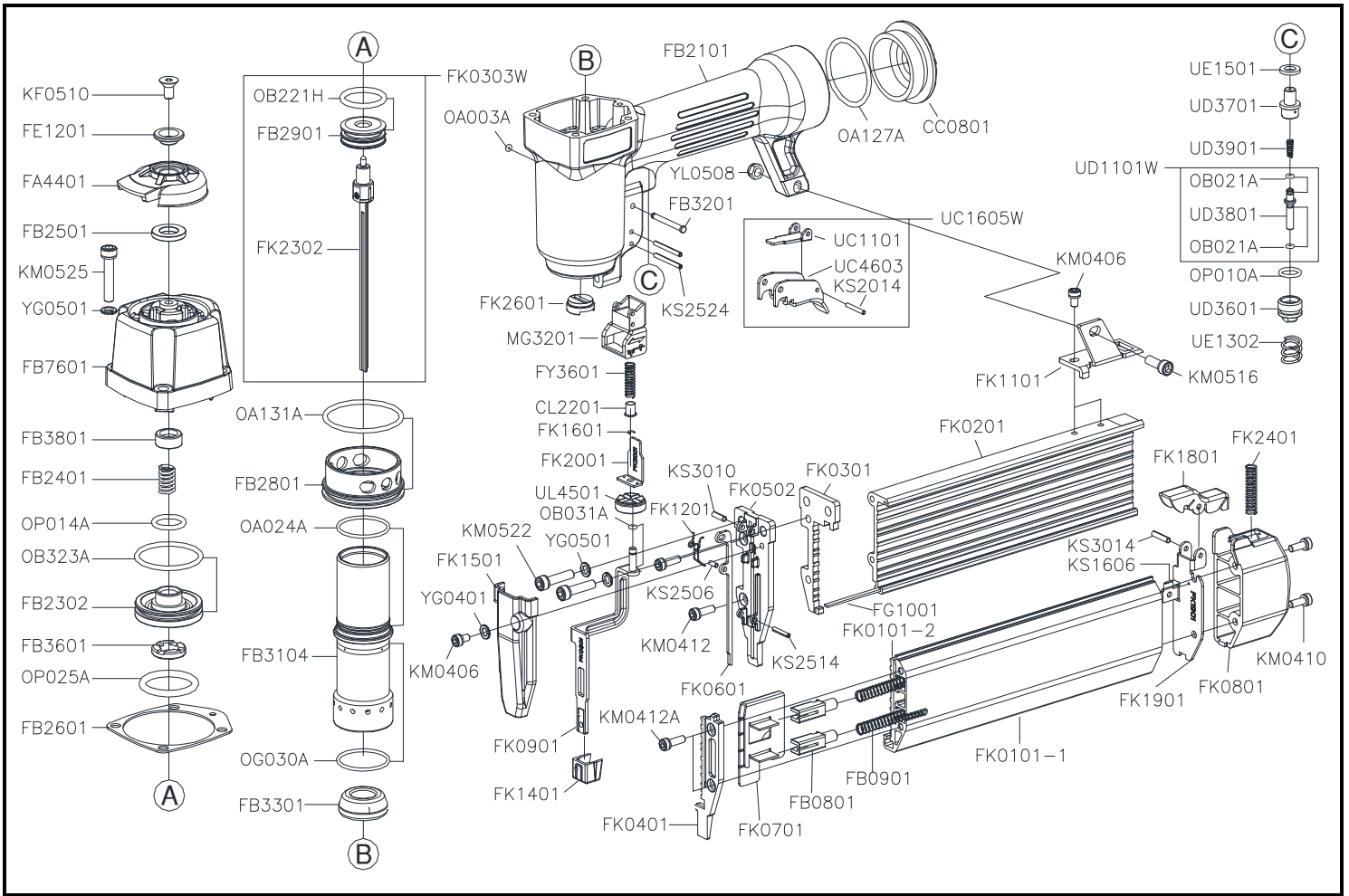

Part_No	Description	Spec	Q'ty	Part_No	Description	Spec	Q'ty	Part_No	Description	Spec	Q'ty
CC0801	END CAP		1	FK0901	WORK CONTACTING ELEMENT		1	OA024A	O-RING	ARP568-024	1
CL2201	BUSHING		1	FK1101	SUPPORT		1	OA127A	O-RING	ARP568-127	1
FA4401	EXHAUST CAP		1	FK1201	SPRING		1	OA131A	O-RING	ARP568-131	1
FB0801	PUSHER PIN		2	FK1401	SAFETY CUSHION		1	OB021A	O-RING	1.8x1.2	2
FB0901	PUSHER SPRING		2	FK1501	PLATE		1	OB031A	O-RING	3x1	1
FB2101	BODY		1	FK1601	C-RING		1	OB221H	O-RING	21.5x3.0	1
FB2302	HEAD VALVE PISTON		1	FK1801	LATCH		1	OB323A	O-RING	31.8x2.4	1
FB2401	COMPRESSION SPRING		1	FK1901	STOP PLATE		1	OG030A	O-RING	G30	1
FB2501	PISTON STOP		1	FK2001	SAFETY		1	OP010A	O-RING	P10	1
FB2601	CAP SEAL		1	FK2302	DRIVER SET		1	OP014A	O-RING	P14	1
FB2801	COLLAR		1	FK2401	COMPRESSION SPRING		1	OP025A	O-RING	P25(1A)	1
FB2901	MAIN PISTON		1	FK2601	NOZZLE		1	UC1101	CONTACT LEVER		1
FB3104	CYLINDER		1	FY3601	COMPRESSION SPRING		1	UC1605W	TRIGGER ASSY.		1
FB3201	PIN		1	KF0510	FLAT HD.BOLT	M5x0.8 - 10L	1	UC4603	TRIGGER		1
FB3301	BUMPER		1	KM0406	HEX.SOC.HD.BOLT	M4x0.7 - 6L	3	UD1101W	TRIGGER VALVE ASSY.		1
FB3601	PISTON STOP		1	KM0410	HEX.SOC.HD.BOLT	M4x0.7 - 10L	2	UD3601	TRIGGER VALVE GUIDE		1
FB3801	PISTON STOP		1	KM0412	HEX.SOC.HD.BOLT	M4x0.7 - 12L	2	UD3701	TRIGGER VALVE SEAT		1
FB7601	CYLINDER CAP		1	KM0412A	HEX.SOC.HD.BOLT	M4x0.7 - 12L	2	UD3801	TRIGGER VALVE STEM		1
FE1201	EXHAUST CAP RING		1	KM0516	HEX.SOC.HD.BOLT	M5x0.8 - 16L	1	UD3901	COMPRESSION SPRING		1
FG1001	BAR		1	KM0525	HEX.SOC.HD.BOLT	M5x0.8 - 25L	4	UE1302	COMPRESSION SPRING		1
FK0101-1	MAGAZINE CAP (1)		1	KS1606	SPRING PIN	φ1.6-6L	1	UE1501	SEAL		1
FK0101-2	MAGAZINE CAP (2)		1	KS2014	SPRING PIN	φ2-14L	1	YL0508	LOCK NUT	M5x0.8	1
FK0201	MAGAZINE SEAT		1	KS2506	SPRING PIN	φ2.5-6L	1				
FK0301	GUIDE PLATE		1	KS2514	SPRING PIN	φ2.5-14L	1				
FK0303W	DRIVER ASSY.		1	KS2524	SPRING PIN	φ2.5-24L	2				
FK0401	FRONT PLATE		1	KS3010	SPRING PIN	φ3-10L	1				
FK0502	COVER PLATE		1	KS3014	SPRING PIN	φ3-14L	1				
FK0601	GUIDE PLATE		1	MG3201	SAFETY SET		1				
FK0701	PUSHER		1	OA003A	O-RING	ARP568-003	1				
FK0801	COVER		1								

★☆☆ If you need to order parts, please mark both Parts No. and Description. ☆☆☆