

B 150 CED 2011 MODEL

UNIT 1

ILLUSTRATED PARTS BREAKDOWN

Edizione 2011
Rev. A

From Serial Number: 31107044

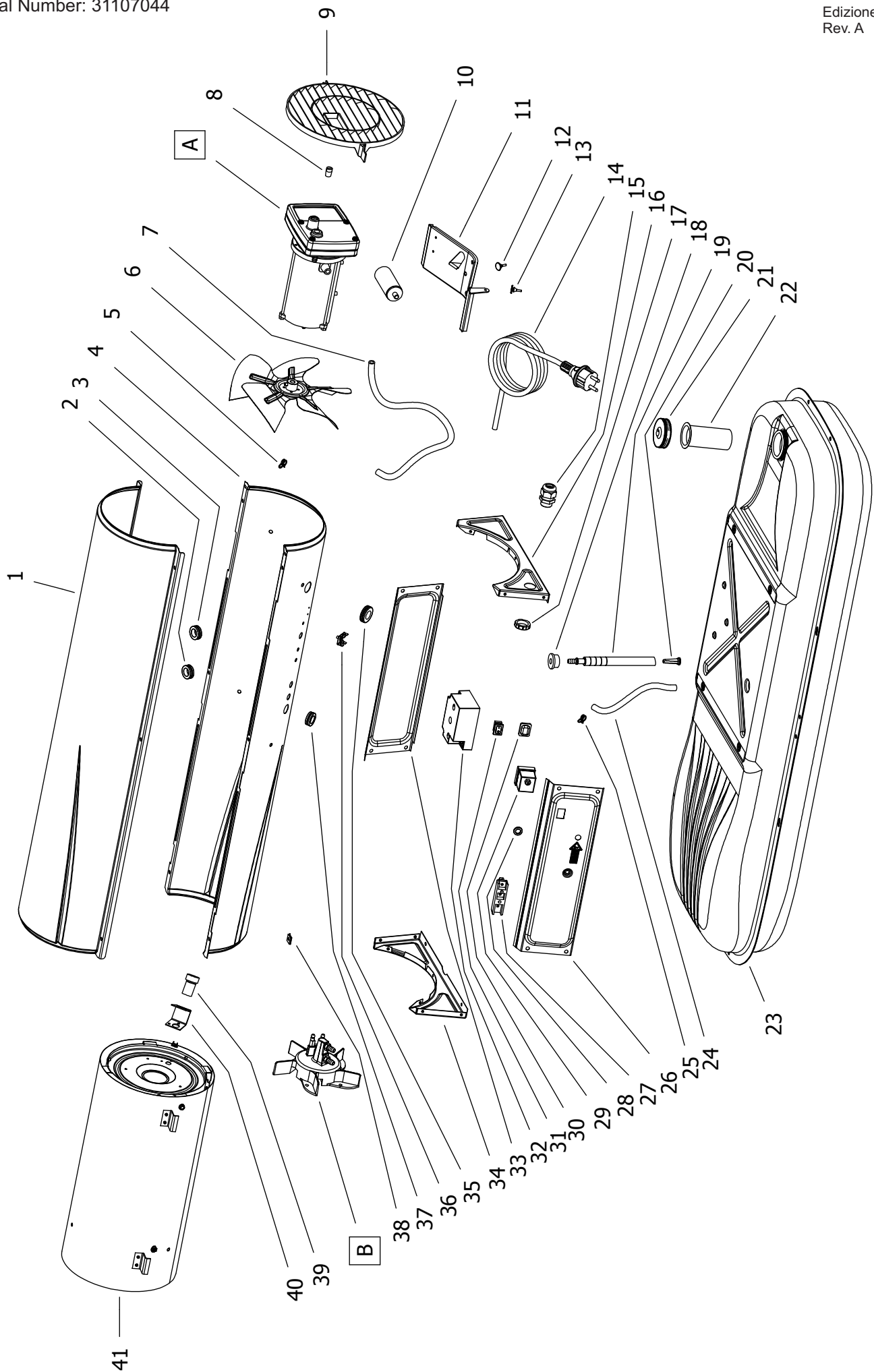

B 150 CED 2011 MODEL

UNIT 2

ILLUSTRATED PARTS BREAKDOWN

A

From Serial Number: 31107044

Edizione 2011
Rev. A

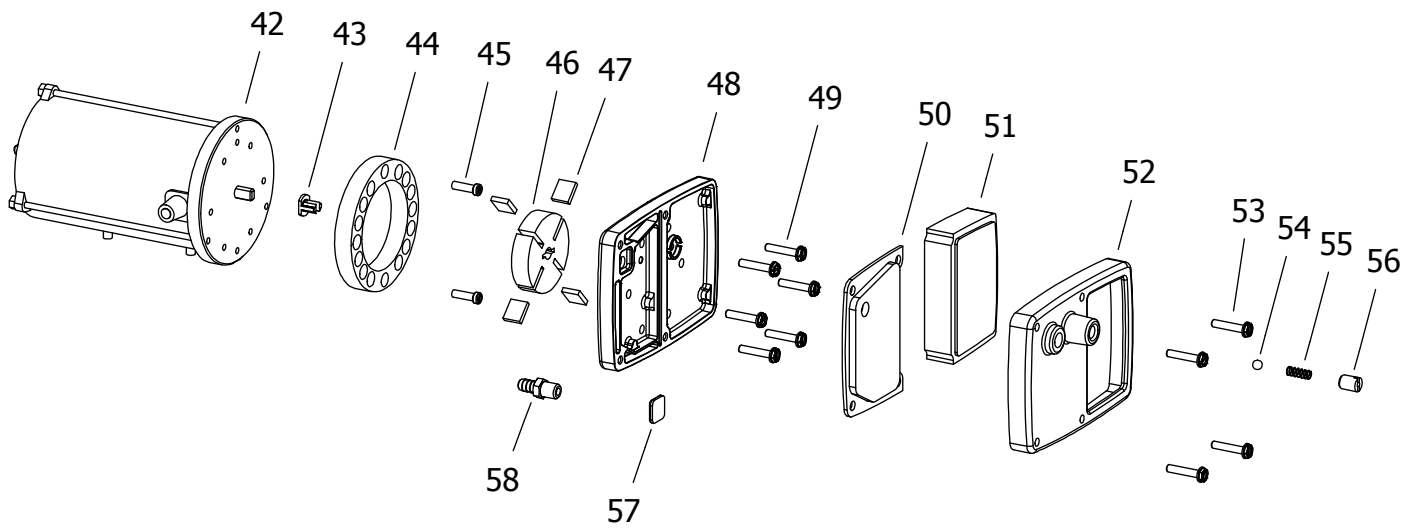

B

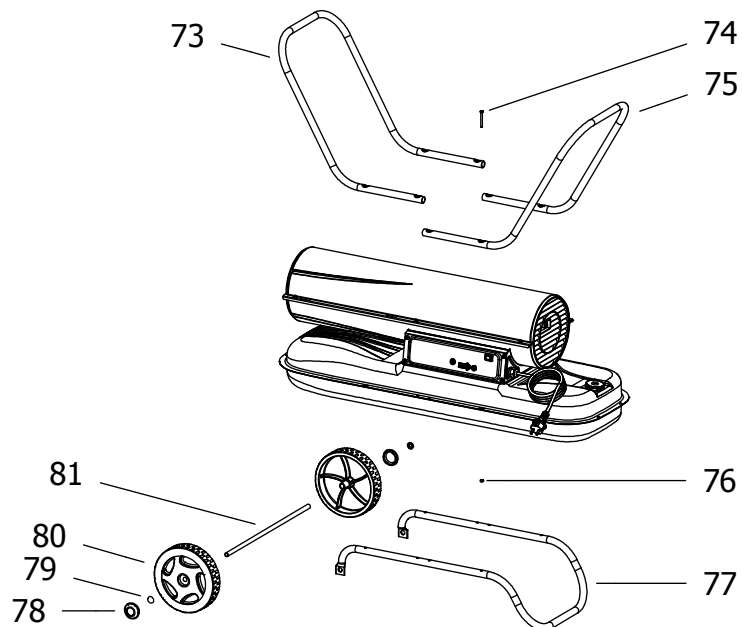
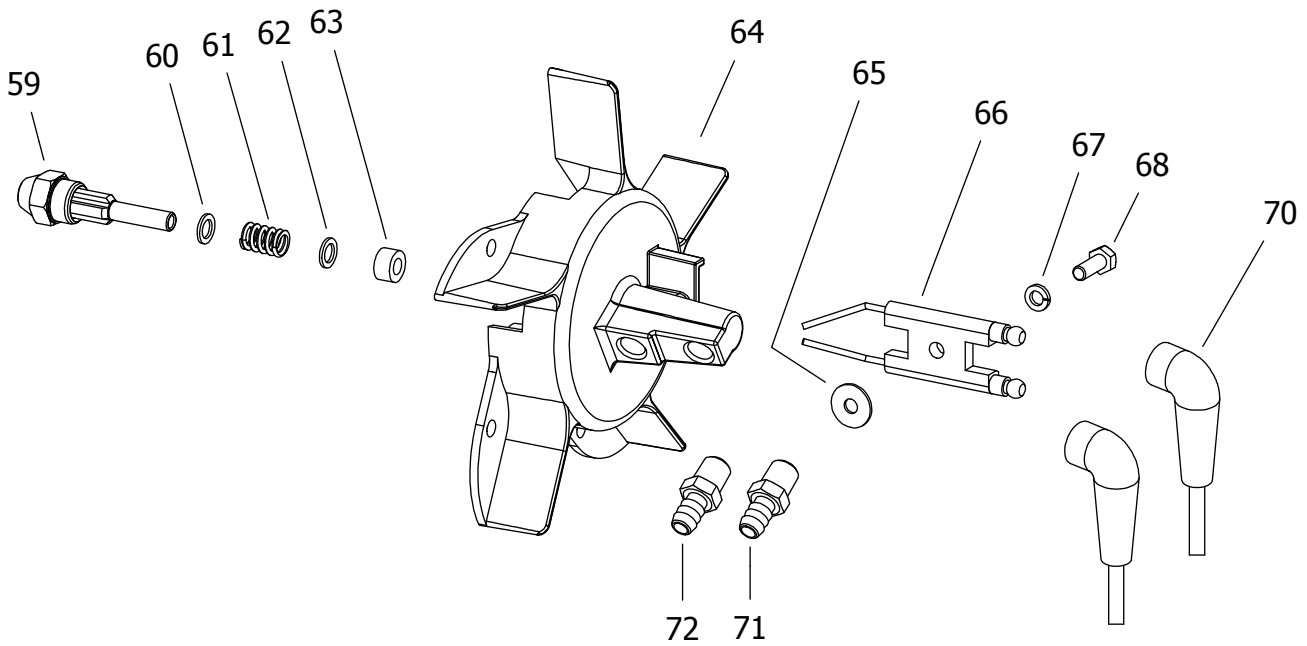

Pos.	Code NR	Description
1	4110.360	UPPER SHELL
2	4100.151	GROMMET
3	4101.151	GROMMET
4	4110.359	LOWER SHELL
5	4110.159	CLAMP
6	4105.062	FAN
7	4104.147	AIR LINE
8	4102.125	PRESSURE GAUGE CAP
9	4103.695	FAN GUARD
10	4110.294	CAPACITOR
11	4101.240	MOTOR BRACKET
12	4150.553	BUMPER
13	4150.553	BUMPER
14	4110.451	POWER CORD
15	4150.528	STRAIN RELIEF
16	4110.353	REAR FRAME BRACKET
17	4100.656	LOCKNUT
18	4100.541	RUBBER BUSHING
19	4110.355	FUEL LINE
20	4110.356	FUEL FILTER
21	4103.891	FUEL TANK CAP
22	4105.292	FUEL TANK FILTER
23	4110.891	FUEL TANK
24	4110.032	FUEL LINE
25	4110.159	CLAMP
26	4111.819	LEFT PANEL
27	4106.110	TERMINAL BOARD
28	4109.592	NUT
29	4104.196	FLAME-OUT CONTROL
30	4104.336	COVER SWITCH
31	4106.179	ON/OFF SWITCH
32	4111.885	ELECTRONIC IGNITOR
33	4110.379	RIGHT PANEL
34	4110.354	FRONT FRAME BRACKET
35	4160.646	GROMMET
36	4160.639	RIVET POP
37	4101.151	GROMMET
38	4104.170	CLIP NUT
39	4110.564	PHOTOCELL ASSEMBLY
40	4100.659	PHOTOCELL BRACKET
41	4110.595	COMBUSTION CHAMBER
42	4110.452	MOTOR 1/4 HP
43	4108.635	INSERT

Pos.	Code NR	Description
44	4101.532	PUMP BODY
45	4108.590	PUMP BODY SCREW
46	4103.441	ROTOR
47	4101.666	BLADE
48	4101.325	PUMP END COVER
49	4108.536	SCREW/LOCKWASHER
50	4101.341	OUTPUT FILTER
51	4101.358	INTAKE FILTER
52	4108.643	END COVER
53	4108.528	SCREW/LOCKWASHER
54	4108.379	STEEL BALL
55	4102.141	PRESSURE RELIEF SPRING
56	4102.133	ADJUSTING SCREW
57	4101.333	LINT FILTER
58	4104.118	BARB FITTING
59	4103.898	NOZZLE
60	4100.525	WASHER
61	4100.533	NOZZLE SEAL SPRING
62	4100.525	WASHER
63	4101.622	NOZZLE SEAL SLEEVE
64	4110.377	BURNER HEAD BODY
65	4110.394	FIBER WASHER
66	4110.337	BIFILAR ELECTRODES
67	4110.393	WASHER
68	4110.363	SCREW
70	4111.831	HT CABLE
71	4104.118	BARB FITTING
72	4104.118	BARB FITTING
73	4110.368	HANDLE
74	4110.144	SCREW
75	4110.368	HANDLE
76	4110.143	LOCK NUT
77	4110.369	WHEEL SUPPORT FRAME
78	4110.129	CAP NUT
79	4110.162	WASHER
80	4110.084	WHEEL
81	4110.370	AXLE