

MODEL B100 CED

UNIT 1

ILLUSTRATED PARTS BREAKDOWN

From Serial Number: 30101606

Edizione 2010
Rev. A

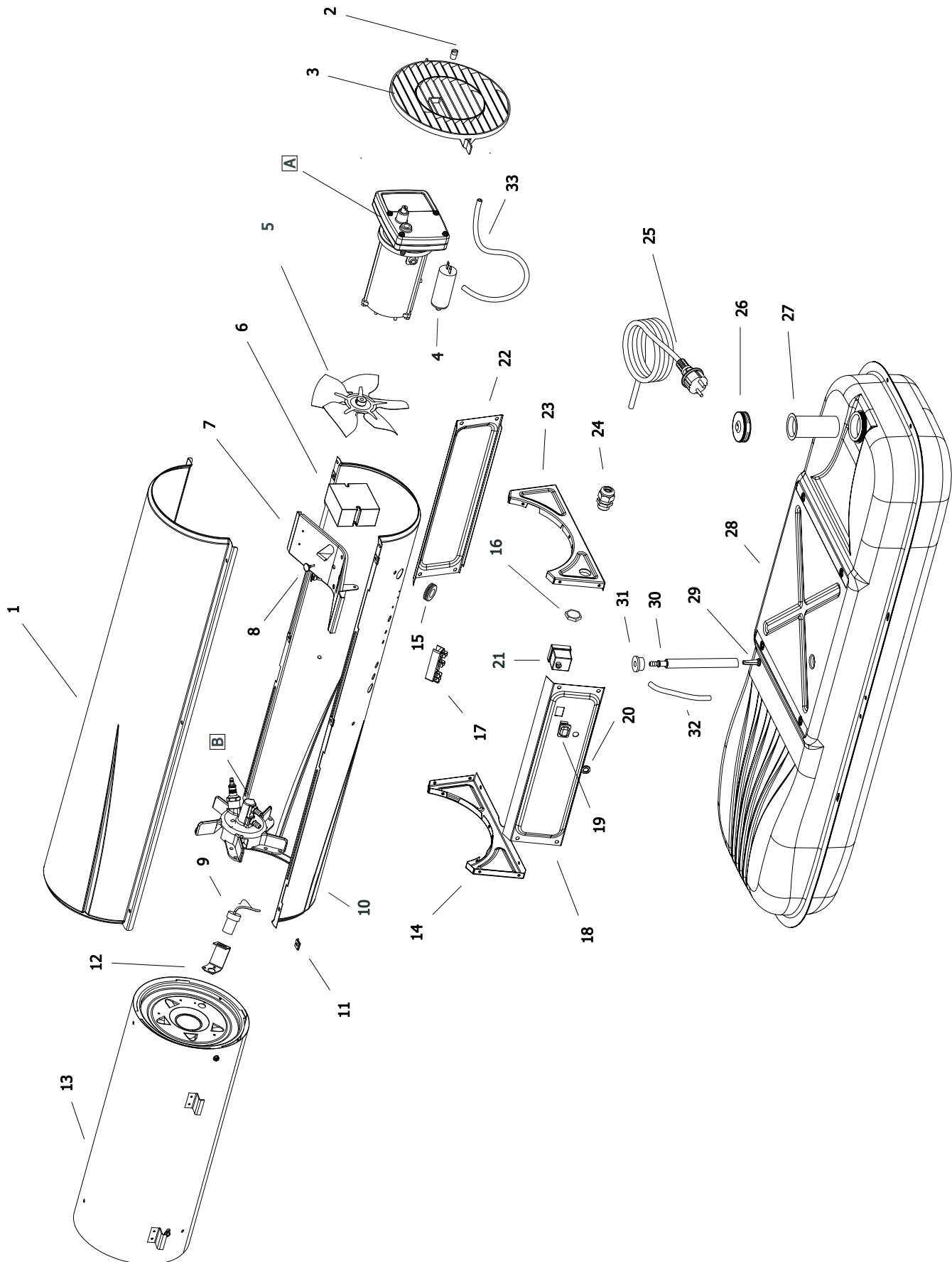

MODEL B100 CED

UNIT 2

ILLUSTRATED PARTS BREAKDOWN

A

From Serial Number: 30101606

Edizione 2010
Rev. A

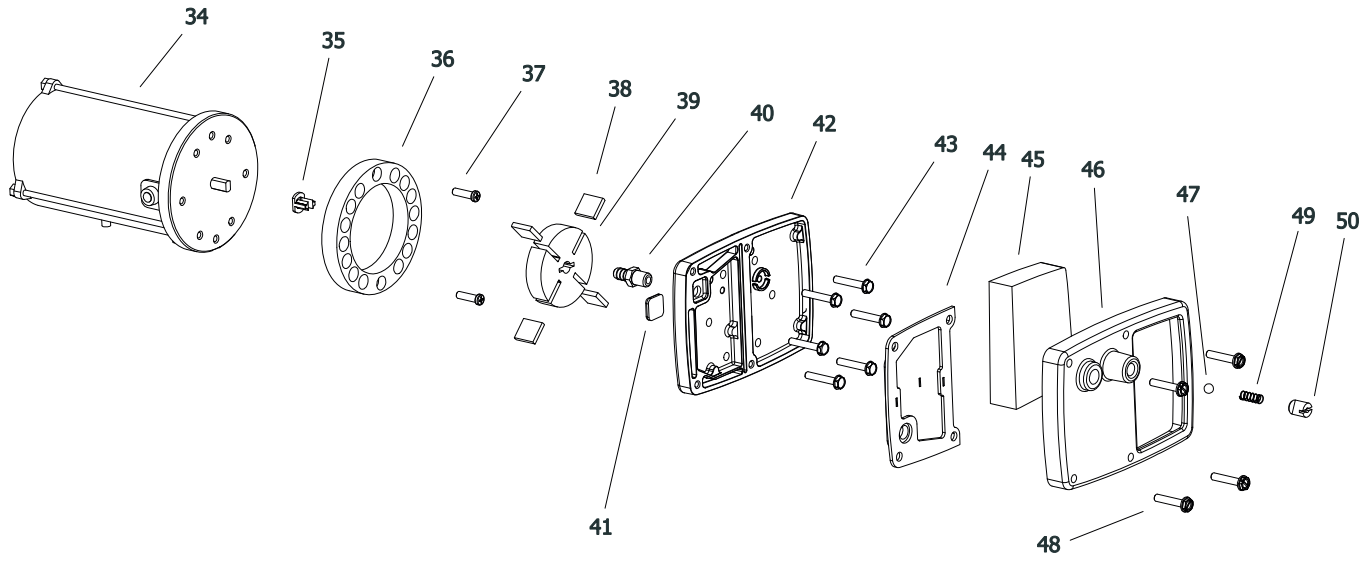

B

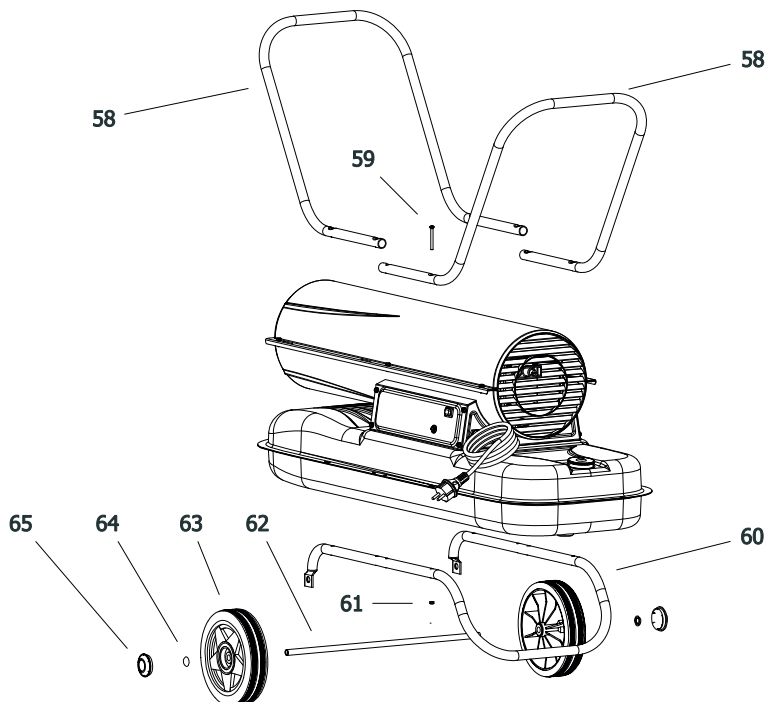
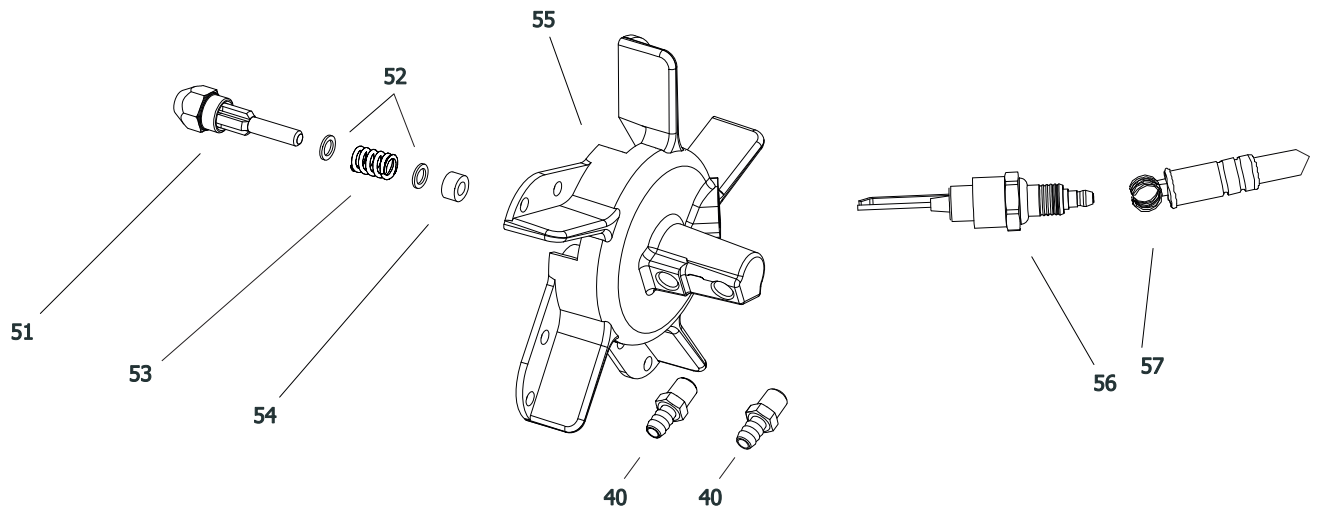

MODEL B 100 CED

Pos.	Code NR	Description
1	S/R	UPPER SHELL
2	4102.125	PRESSURE GAUGE CAP
3	4103.695	FAN GUARD
4	4110.294	CAPACITOR
5	4105.062	FAN
6	4110.453	ELECTRONIC IGNITOR
7	4101.240	MOTOR BRACKET
8	4150.553	BUMPER
9	4110.564	PHOTOCELL ASSEMBLY
10	S/R	LOWER SHELL
11	4104.170	CLIP NUT
12	4100.658	PHOTOCELL BRACKET
13	4101.180	COMBUSTION CHAMBER
14	4110.354	FRONT FRAME BRACKET
15	4160.646	CABLE PROTECTION
16	4100.656	LOCKNUT
17	4106.110	TERMINAL BOARD
18	4110.417	LEFT PANEL
19	4106.179	ON/OFF SWITCH
20	4109.592	NUT
21	4104.196	FLAME-OUT CONTROL
22	4110.379	RIGHT PANEL
23	4110.353	REAR FRAME BRACKET
24	4150.528	STRAIN RELIEF
25	4110.486	POWER CORD
26	4103.891	FUEL TANK CAP
27	4105.292	FUEL TANK FILTER
28	4110.891	FUEL TANK
29	4110.356	FUEL FILTER
30	4110.355	FUEL LINE
31	4100.541	RUBBER BUSHING
32	4110.032	FUEL LINE
33	4104.147	AIR LINE
34	4110.452	MOTOR 1/4 HP
35	4108.635	INSERT
36	4101.317	PUMP BODY
37	4108.588	PUMP BODY SCREW
38	4101.200	BLADE
39	4108.627	ROTOR

MODEL B 100 CED

Pos.	Code NR	Description
40	4104.118	BARB FITTING
41	4101.333	LINT FILTER
42	4101.325	PUMP END COVER
43	4108.536	SCREW/LOCKWASHER 4,8x30
44	4101.341	OUTPUT FILTER
45	4101.358	INTAKE FILTER
46	4108.643	END COVER
47	4108.379	STEEL BALL
48	4108.528	SCREW/LOCKWASHER 4,8x25
49	4102.141	PRESSURE RELIEF SPRING
50	4102.133	ADJUSTING SCREW
51	4103.559	NOZZLE
52	4100.525	WASHER
53	4100.533	NOZZLE SEAL SPRING
54	4101.622	NOZZLE SEAL SLEEVE
55	4109.352	BURNER HEAD BODY
56	4101.846	SPARK PLUG
57	4110.194	HT CABLE
58	4110.368	HANDLES
59	4110.144	SCREW
60	4110.369	WHEEL SUPPORT FRAME
61	4110.143	LOCK NUT
62	4110.370	AXLE
63	4110.084	WHEEL
64	4110.162	WASHER
65	4110.129	CAP NUT

S/R = Parts available on special request only