

OPERATING INSTRUCTIONS AND PARTS MANUAL

MODEL 80/16LNR

Stapler

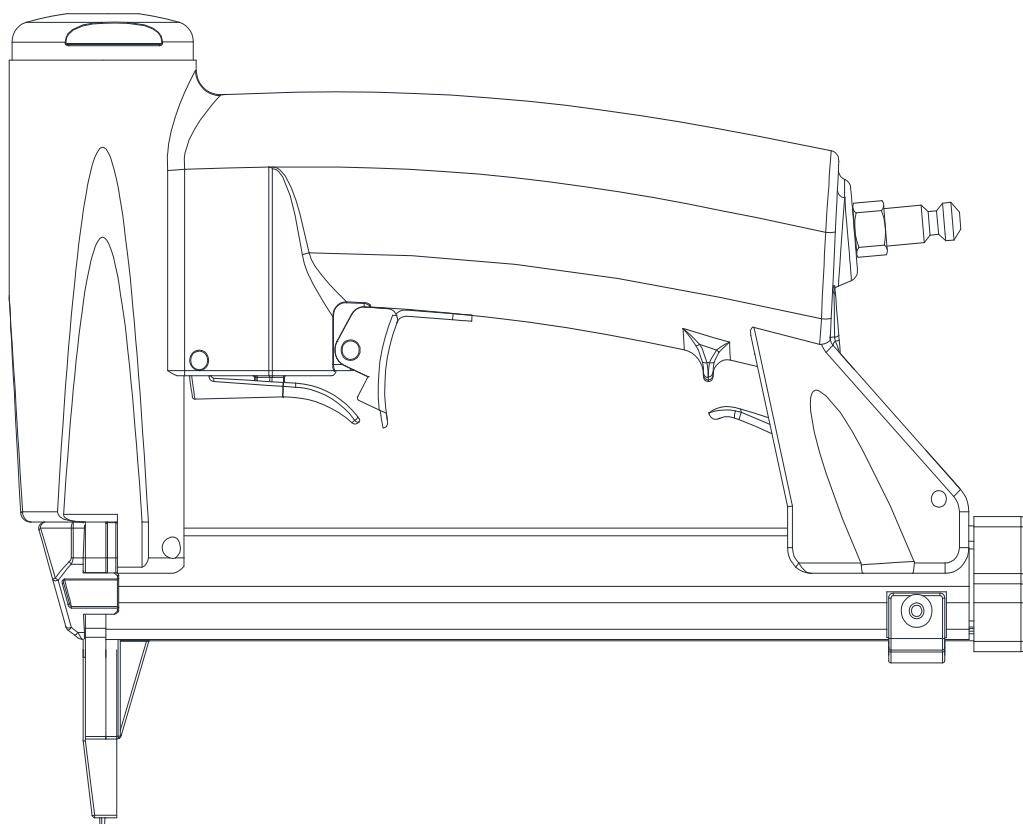

CAREFULLY READ THIS MANUAL BEFORE OPERATING TOOL

APLUS Pneumatic Corp.
NO.579, SEC. 1, SHEN LIN RD., TAYA, TAICHUNG CITY 428 TAIWAN, R.O.C.
Tel: 886-4-25602860 Fax: 886-4-25602859
Original instructions

OPERATING INSTRUCTIONS AND PARTS MANUAL

MODEL 80/16LNR

Stapler

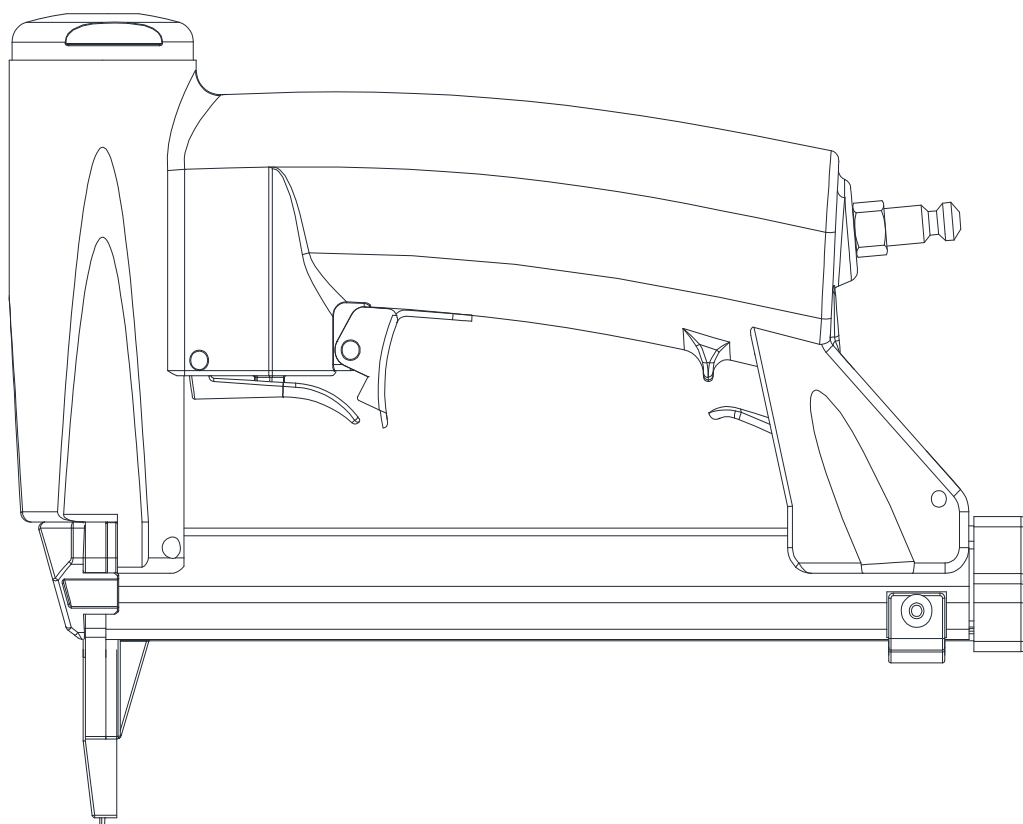

CAREFULLY READ THIS MANUAL BEFORE OPERATING TOOL

TOOL SPECIFICATIONS

MODEL OF TOOL	80/16LNR
TOOL LENGTH	8.26" (210 mm)
TOOL HEIGHT	5.51" (140 mm)
TOOL WIDTH	1.57" (40 mm)
WEIGHT (WITHOUT FASTENERS)	1.98 lbs (0.9 kg)
AIR INLET	1/4" NPT

COMPRESSED AIR :

Maximum permissible operating pressure	110 PSIG (7.5 bar)
Recommended operating pressure range	60 ~ 100 PSIG (4 ~ 7 bar)
AIR CONSUMPTION.....	0.0054 scfm with 25 nails per minute @ 100 psi (6.9 bar)

Noise dB(A) :

A-weighted single event sound pressure level LpA : 94.7 dB(A)

A-weighted single event sound power level LWA: 107.7 dB(A)

Measurement uncertainty: 3dB

Vibration (m/s²) :

Hand-arm vibration value: 0.87 m/s²

Measurement uncertainty: 1.5 m/s²

Warning:

The vibration emission during actual use of the power tool can differ from the declared total value depending on the ways in which the tool is used; and of the need to identify safety measures to protect the operator that are based on an estimation of exposure in the actual conditions of use (taking account of all parts of the operation cycle such as the times when the tool is switched off and when it is running idle in addition to the trigger time).

List of fasteners for 80/16LNR :

Crown	Thickness	Width	MAGAZINE
12.9 mm , 0.51 "	0.65 mm 0.026 "	0.95 mm 0.037 "	150 pcs

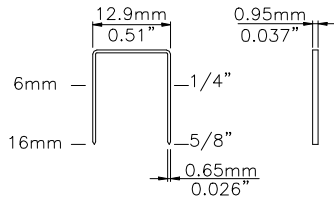

Foreword:

This pneumatic stapler is designed for moulding, hobbies and most other jobs requiring a hammer. Its well balanced, ergonomic, comfort non-slip cushioned grip and heavy duty driving compatible staples to proper applications. Features long protruding nose to nail/staple into tight corners/groves, easy loading magazine are exactly what master needed. No more painful hammering and ensure you as satisfactory tackle and enjoy work.

Suitable applications:

Wood and wood like applications, MDF, Hobby/Craft, fine decorative trim, beading and moulding. Tongue & Groove paneling. Cabinet and plywood assembly, garden furniture and trellis work, door/window assembly, hardwood flooring, paneling and trim. Picture/mirror frames. Sub-flooring and many more.... This electric tool is restricted to using on wood, wood like products, leather and material of paper. Any other material is forbidden.

Caution:

Not suitable for stapling or nailing into concrete, masonry bricks or steel. Do not fire if nails are jammed, as this will cause damage to the driver blade.



Indicates an imminently hazardous situation which, if not avoided, will result in death or serious injury.



Indicates a potentially hazardous situation which, if not avoided, will result in death or serious injury.



Alerts the operator to useful information.

SAFETY INSTRUCTIONS



1. Read this manual and understand all safety instructions before operation the tool. If you have any questions, please contact our authorized representatives.
2. Only those fasteners listed in the operating instructions may be used in the fastener driving tools.
3. Only the main energy and the lubricants listed in the operating instructions may be used.
4. Fastener driving tools marked with an inverted equilateral triangle standing on one point may only be used with an effective safety yoke.
5. Fastener driving tools equipped with contact actuation or continuous contact actuation, marked with the symbol " Do not use on scaffoldings, ladders", shall not be used for specific application for example:
 - when changing one driving location to another involves the use of scaffoldings, stairs, ladders, or ladder alike constructions, e.g. roof laths,

—closing boxes or crates,

—fitting transportation safety systems e.g. on vehicles and wagons.

6. For the maintenance of fastener driving tools, only spare parts specified by the manufacturer or his authorized representative shall be used.
7. Repairs shall carried out by agents authorized by the manufacturer or by other specialists, having due regard to the information given in the operating instruction.
8. Stands for mounting the fastener driving tools to a support for example a work table shall be designed and constructed by the stand manufacturer in such a way that the fastener driving tool can be safely fixed for the intended use, thus for example avoiding damage, distortion or displacement.
9. Fastener driving tools operated by compressed air shall only be connected to compressed air lines where the maximum allowable pressure cannot be exceed by a factor of more than 10%, which can for example be achieved by a pressure reduction valve which includes a downstream safety valve.
10. When using fastener driving tools operated by compressed air, particular attention must be paid to avoid exceeding the maximum allowable pressure.
11. When using fastener driving tools operated by compressed air should only be operated at the lowest pressure required for the work process at hand, in order to prevent unnecessarily high noise levels, increased wear and resulting failures.
12. Hazards caused by fire and explosion when using oxygen or combustible gases for operating compressed air operated fastener driving tools.
13. Carry the fastener driving tool at workpiece using only the handgrip, and never with the trigger actuated. Never carry the tool by the hose or pull the hose to move the tool.

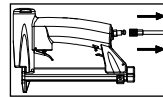

14. Disconnect the tool from air supply before cleaning jams, servicing, adjusting, and during non-operation.



15. Wear eye protection.

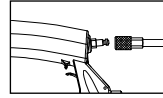

16. Do not use a check valve or any other fitting which allows air to remain in the tool.



17. Do not place your hand or any part of your body in the fastener discharge area of the tool when connecting or disconnecting air supply.



18. Never point tool at yourself or at any other person.

AIR SUPPLY AND CONNECTION



NOTE

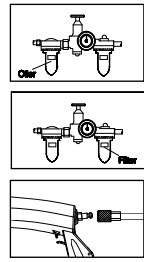

- Many air tool users find it convenient to use oiler to help provide oil circulation through tool and increase the efficiency and useful life of the tool. Check oil level in the oiler daily.
- Many air tool user find it convenient to use a filter to remove liquid and impurities which can rust or wear internal parts of the tool. A filter also increase the efficiency and useful of the tool. The filter must be checked on a daily basis and if necessary drained.
- For better performance, install a 3/8" quick connector (1/4" NPT threads) with an inside diameter of .315" on your tool and a 3/8" quick coupler on the air hose.

The following illustration shows the correct mode of connection to the air supply system which will increase the efficiency and useful life of the tool.

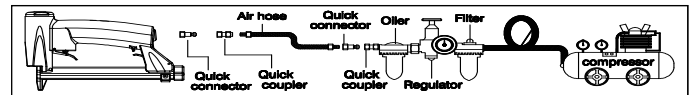

LUBRICATION AND MAINTENANCE



NOTE

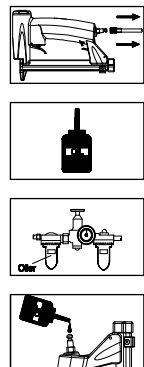

- Disconnect the air supply from the tool before lubricating.
- Your tool requires lubrication before you use it for the first time.
- Wipe off excessive oil at the exhaust. Excessive oil will damage O-rings of tool. If in-line oiler is used, manual lubrication through the air inlet is not required on a daily basis.
- Turn the tool so the inlet is facing up and put one drop of high speed spindle oil, UNOCAL RX22, or 3-IN-1 oil into air inlet. Never use detergent oil or additives. Operate the tool briefly after adding oil.

LOADING THE TOOL

⚠️ WARNING



- Do not place your hand or any part of your body in the fastener discharge area of the tool when connecting or disconnecting air supply.

⚠️ WARNING



- Never point any operational fastener driving tool at yourself or at any other person.

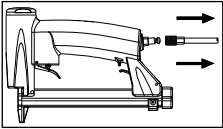

1. Disconnect air hose.

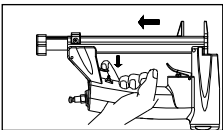

2. Depress the magazine latch. Pull back on the magazine cover.

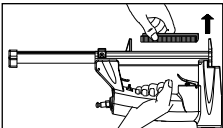

3. Insert a stick of fasteners into the magazine. Make sure the pointed ends of the fasteners are loaded with the points upward. Also make sure fasteners are not dirty or damaged.

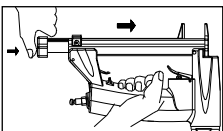

4. Push the magazine cover forward until the latch catches.

OPERATING THE TOOL

⚠️ WARNING



Protect your eyes and ears. Wear z87.1 safety glasses with side shields. Wear hearing protection. Employers and users are responsible for ensuring the user or anyone near the tool wear this safety protection.

⚠️ NOTE

Check and replace any damaged or worn components on the tool. The safety warning labels on the tool must also be replaced if they are not legible.



Fig.1

1. Add a few drops of UNOCAL RX22 or 3-in-1 oil into the air inlet. (See Fig. 1)

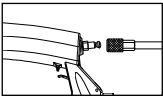

Fig.2

2. Attach a high flow quick connect fitting to the tool. (See Fig. 2)

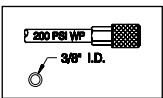

Fig.3

3. Empty the magazine.
4. Connect the tool to an air compressor using a 3/8" I.D hose. Make sure the hose has a rated working pressure exceeding 200 PSI (13.8bar) and a female quick coupler. (See Fig. 3)

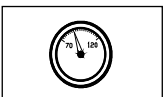

Fig.4

5. Regulate the air pressure to obtain 70 PSI (4.8 bar) at the tool. (See Fig. 4)

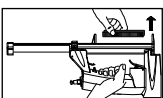

Fig.5

6. Disconnect the air supply from the tool.

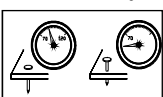

Fig.6

7. Load fasteners into your tool following the instructions in this manual. (See Fig. 5)

8. Reconnect the air supply to the tool.

9. Test for proper fastener penetration by driving nails into a sample piece of wood. If the fasteners do not achieve the desired penetration, adjust the air pressure to a higher setting until the desired penetration is achieved. Do not exceed 110 PSI (7.6 bar) at the tool. (See Fig. 6)

CLEARING A JAM FROM THE TOOL

⚠️ WARNING

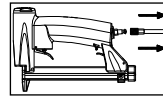

Disconnect the tool from air compressor before adjusting, clearing jams, servicing, relocating and during non-operation.

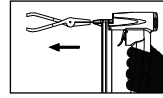

1. Fastener jammed in fastener discharge area:
 - Disconnect tool from air hose.
 - Grab jammed fastener with pliers and remove.

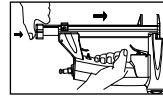

2. Fastener jam inside magazine:
 - Disconnect air tool from air hose.
 - Pull back on fastener pusher until locked.
 - Removed jammed fastener.
 - Release fastener pusher.

CLEANING THE TOOL

⚠️ DANGER ⚠️



Never use gasoline or other flammable liquids to clean the tool. Vapors in the tool will ignite by a spark and cause the tool to explode and result in death or serious personal injury.

⚠️ NOTE

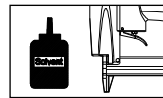

Solvents used to clean the nose of the tool and contact safety trip mechanism may soften the tar on the shingles and cause the buildup to be accelerated. Make sure to dry the tool thoroughly after cleaning and before operating the tool again.

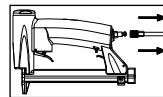

1. Disconnect the air supply from the tool.

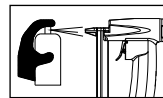

2. Remove tar buildup with kerosene #2 fuel oil or diesel fuel. Do not allow solvent to get into the cylinder or damage may occur. Dry off the tool completely before use.

TROUBLESHOOTING

Stop using the tool immediately if any of the following problems occur. Serious personal injury could. Any repairs or replacements must be done by a qualified person or an authorized service center only.

PROBLEM	PROBABLE CAUSE	REMEDY
Air leaking at trigger valve area.	O-rings in trigger valve housing are damaged.	O-rings must be replaced.
	Loose screws in housing.	Screws need to be tightened.
Air leaking between housing and nose.	Damaged to bumper.	O-rings must be replaced.
	Damage to bumper.	Bumper needs to be tightened.
Air leaking between housing and cap Assy.	Loose screws.	Screws need to be tightened.
	Damaged seal.	Seal needs to be replaced.
Tool skips driving fastener.	Worn bumper.	Bumper needs to be replaced.
	Dirt in nose.	Clean.
	Dirt or damage prevents fasteners from moving freely in magazine.	Magazine needs to be cleaned.
	Inadequate air flow to tool.	Fitting hose or air compressor needs to be checked.
	Worn O-ring on piston or lack of lubrication.	O-ring needs to be replaced. Lubricate.
	Damaged O-rings on trigger valve.	O-rings need to be replaced.
	Air leaks.	Screws and fittings need to be tightened.
	Cap seal leaking.	Seal needs to be replaced.
Tool runs slow or has loss of power.	Tool not lubricated sufficiently.	Tools needs to be lubricated.
	Broken spring in cap Assy.	Spring needs to be replaced.
	Exhaust port in cap is blocked.	Damaged internal parts need to be replaced.
Fasteners are jammed in tool.	Driver nozzle worn or damaged.	Replace driver nozzle.
	Driver is damaged.	Replace driver.
	Fasteners are not correct size.	Fasteners recommended for tool must be used.
	Fasteners are bent.	Replace with undamaged fastener.
	Magazine or nose screws are loose.	Screws need to be tightened.

80/16LNR35 (UG/A1-35)

A

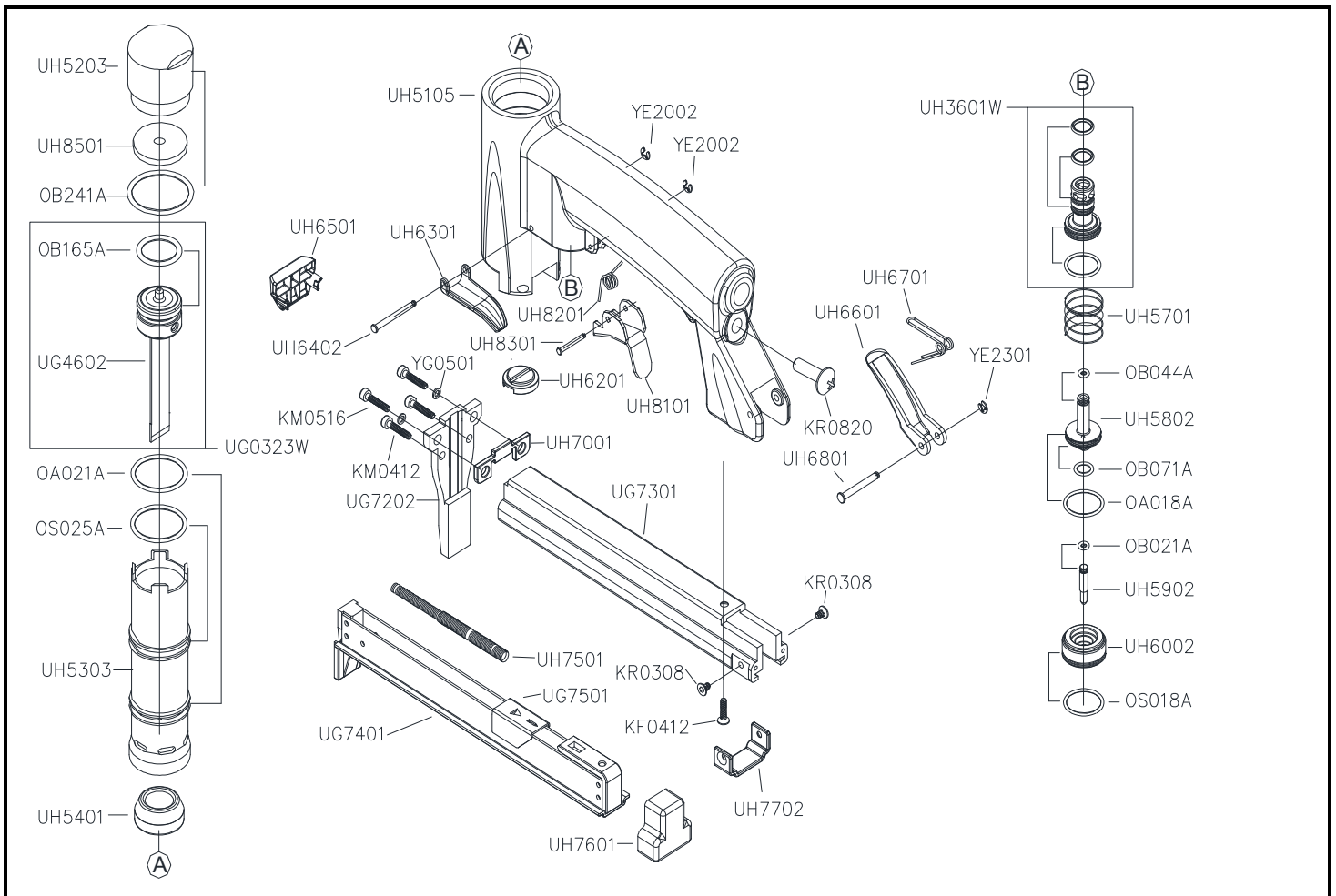

Part_No	Description	Spec	Q'ty	Part_No	Description	Spec	Q'ty	Part_No	Description	Spec	Q'ty
KF0412	FLAT HD.BOLT	M4×0.7 - 12L	1	UH5203	HAMMER CAP HAMMER		1	YE2002	E-RING	φ2.0	2
KM0412	HEX.SOC.HD.BOLT	M4×0.7 - 12L	2	UH5303	CYLINDER		1	YE2301	E-RING	φ2.3	1
KM0516	HEX.SOC.HD.BOLT	M5×0.8 - 16L	2	UH5401	BUMPER		1	YG0501	SPRING WASHER	φ5	2
KR0308	BUTTON HD.BOLT	M3×0.5 - 8L	2	UH5701	TRIGGER VALVE SPRING		1				
KR0820	BUTTON HD.BOLT	M8×1.25 - 20L	1	UH5802	PILOT VALVE BODY		1				
OA018A	O-RING	ARP568-018	1	UH5902	TRIGGER VALVE STEM		1				
OA021A	O-RING	ARP568-021	1	UH6002	TRIGGER VALVE GUIDE		1				
OB021A	O-RING	1.8×1.2	1	UH6201	SEAL		1				
OB044A	O-RING	4.5×1.5	1	UH6301	TRIGGER		1				
OB071A	O-RING	7×1	1	UH6402	PIN		1				
OB165A	O-RING	16.3x2.4	1	UH6501	PLATE		1				
OB241A	O-RING	24x2	1	UH6601	LATCH		1				
OS018A	O-RING	S-18	1	UH6701	LATCH SPRING		1				
OS025A	O-RING	S-25	1	UH6801	PIN		1				
UG0323W	DRIVER ASSY.		1	UH7001	COVER PLATE(B)		1				
UG4602	DRIVER SET		1	UH7501	PULL SPRING		1				
UG7202	COVER PLATE		1	UH7601	REAR MAGAZINE BUMPER		1				
UG7301	MAGAZINE SEAT		1	UH7702	MAGAZINE RETAINER		1				
UG7401	MAGAZINE CAP		1	UH8101	TRIGGER STOP		1				
UG7501	PUSHER		1	UH8201	SPRING		1				
UH3601W	TRIGGER VALVE SET		1	UH8301	PIN		1				
UH5105	BODY		1	UH8501	SPACER		1				

★☆☆ If you need to order parts, please mark both Parts No. and Description. ☆☆☆

2021/8/13